



# 2019 WaveRunner SuperJet

## OWNER'S/OPERATOR'S MANUAL

 Read this manual carefully  
before operating this watercraft.

---

**YAMAHA MOTOR CO., LTD.**  
F4D-28199-75-E0

### **IMPORTANT NOTICE**

This personal watercraft is intended solely for racing. The use of this machine should be limited to designated areas or events.

**Read this manual carefully before operating this watercraft. This manual should stay with the WaveRunner if it is sold.**

# Important manual information

EJU3008J

## Declaration of Conformity for Personal Watercraft (PWC)

Name of PWC Manufacturer: YAMAHA MOTOR CO., LTD.

Address: 2500 Shingai, Iwata, Shizuoka 438-8501, Japan

Name of Authorised Representative: YAMAHA MOTOR EUROPE N.V.

Address: Koolhovenlaan 101, 1119 NC Schiphol-Rijk, The Netherlands

### Community Directives Applied

Directives	Standards
<input checked="" type="checkbox"/> Electromagnetic Compatibility Directive 2014/30/EU	<input checked="" type="checkbox"/> EN 55012:2007/A1:2009
	<input checked="" type="checkbox"/> EN 61000-6-2:2005

### DESCRIPTION OF WATERCRAFT AND ENGINE

Craft Identification Number : starting from

J P - Y A M H 0 0 0 1 E 8 1 9

Brand name :

YAMAHA

Model name / Commercial name :

SJ700B-U / SuperJet

Type of Watercraft :

Personal Watercraft

Fuel Type :

Petrol

Engine Power (kW) :

48.5

Length / Beam of hull (meter) :

2.24 / 0.68

This personal watercraft is intended solely for racing in the European Union and does not conform to the Recreational Craft Directive 2013/53/EU.

This declaration is issued under the sole responsibility of the manufacturer. I declare on behalf of the manufacturer that the PWC mentioned above complies with all applicable essential requirements in the way specified.

Name / Title: T. Ibata / Director, Boat Business Unit

(Identification of the person empowered to sign on behalf of the manufacturer)

Signature: \_\_\_\_\_



Date and place of issue: May 1<sup>st</sup>, 2018, Shizuoka, Japan

# Important manual information

---

EJU30193

## To the owner/operator

Thank you for choosing a Yamaha watercraft. This owner's/operator's manual contains information you will need for proper operation, maintenance, and care. If you have any questions about the operation or maintenance of your watercraft, please consult a Yamaha dealer.

This manual is not a course on boating safety or seamanship. If this is your first watercraft, or if you are changing to a type of watercraft you are not familiar with, for your own comfort and safety, please ensure that you obtain proper training or practice before operating the watercraft by yourself. In addition, a Yamaha dealer or boating organization will be pleased to recommend local sea schools, or competent instructors.

In this manual, information of particular importance is distinguished in the following ways:

 This is the safety alert symbol. It is used to alert you to potential personal injury hazards. Obey all safety messages that follow this symbol to avoid possible injury or death.

EWJ00072

### **WARNING**

**A WARNING indicates a hazardous situation which, if not avoided, could result in death or serious injury.**

---

ECJ00092

### **NOTICE**

**A NOTICE indicates special precautions that must be taken to avoid damage to the watercraft or other property.**

---

### **TIP:**

A TIP provides key information to make procedures easier or clearer.

EJU40411

Because Yamaha has a policy of continuing product improvement, this product may not be exactly as described in this owner's/operator's manual. Specifications are subject to change without notice.

This manual should be considered a permanent part of this watercraft and should remain with it even if the watercraft is subsequently sold.

EJU30213

**WaveRunner SuperJet  
OWNER'S/OPERATOR'S MANUAL  
©2018 by Yamaha Motor Co., Ltd.  
1st Edition, February 2018  
All rights reserved.  
Any reprinting or unauthorized use  
without the written permission of  
Yamaha Motor Co., Ltd.  
is expressly prohibited.  
Printed in Japan**

# Table of contents

<b>General and important labels</b> .....	<b>1</b>	<b>Equipment operation</b> .....	<b>23</b>
Identification numbers .....	1	Equipment.....	23
Primary Identification (PRI-ID)		Hood.....	23
number.....	1	Bow rope hole .....	24
Craft Identification Number (CIN).....	1	Stern rope hole.....	24
Engine serial number.....	1	Storage pouch.....	24
Manufactured date label .....	2	Fire extinguisher container.....	25
Important labels .....	3		
Warning labels.....	4	<b>Operation and handling</b>	
Other labels .....	7	<b>requirements</b> .....	<b>27</b>
		Fuel and engine oil	
<b>Safety information</b> .....	<b>8</b>	requirements.....	27
Limitations on who may operate		Fuel.....	27
the watercraft .....	8	2-stroke engine oil.....	28
Cruising limitations.....	9	Mixing fuel and oil .....	28
Operation requirements .....	10	Filling the fuel tank .....	28
Recommended equipment .....	12	Draining the bilge water .....	29
Hazard information.....	13	Draining the bilge water on water ....	29
Watercraft characteristics .....	13	Transporting.....	30
Safe boating rules .....	14		
Enjoy your watercraft		<b>First-time operation</b> .....	<b>32</b>
responsibly.....	15	Engine break-in.....	32
<b>Description</b> .....	<b>16</b>	<b>Pre-operation checks</b> .....	<b>33</b>
Watercraft glossary .....	16	Pre-operation checklist .....	33
Location of main components .....	17	Pre-operation check points .....	35
		Pre-launch checks .....	35
<b>Control function operation</b> .....	<b>19</b>	Post-launch checks.....	39
Watercraft control functions .....	19		
Engine stop switch .....	19	<b>Operation</b> .....	<b>40</b>
Engine shut-off switch .....	19	Operating your watercraft.....	40
Start switch .....	19	Getting to know your watercraft.....	40
Throttle lever .....	20	Learning to operate your	
Steering system .....	20	watercraft.....	40
Steering pole.....	20	Operating positions .....	40
Fuel cock knob.....	21	Launching the watercraft .....	41
Choke knob .....	21	Starting the engine on water .....	41
Cooling water pilot outlet .....	21	Stopping the engine .....	43
Water separator.....	22	Leaving the watercraft.....	43
Engine overheat warning system ....	22	Operating the watercraft .....	43
		Turning the watercraft .....	43
		Stopping the watercraft.....	45
		Starting off.....	45

# Table of contents

---

Capsized watercraft .....	48	<b>Index.....</b>	<b>70</b>
Beaching the watercraft .....	49		
Operating in weeded areas .....	49		
After removing the watercraft from the water.....	49		
<b>Care and storage.....</b>	<b>50</b>		
Post-operation care .....	50		
Flushing the cooling water passages.....	50		
Cleaning the watercraft .....	51		
Battery care.....	51		
Long-term storage .....	54		
Cleaning .....	54		
Lubrication .....	54		
Rustproofing.....	55		
<b>Maintenance .....</b>	<b>56</b>		
Maintenance.....	56		
Tool kit.....	56		
Adjusting the steering friction .....	56		
Adjusting the jet thrust nozzle angle .....	57		
Periodic maintenance chart .....	59		
Checking the spark plugs .....	60		
Lubrication points .....	61		
Checking the fuel filter .....	61		
Adjusting the choke cable.....	61		
Adjusting the carburetor.....	61		
<b>Specifications .....</b>	<b>63</b>		
Specifications.....	63		
<b>Trouble recovery .....</b>	<b>64</b>		
Troubleshooting .....	64		
Troubleshooting chart .....	64		
Emergency procedures.....	66		
Cleaning the jet intake and impeller .....	66		
Jumping the battery .....	67		
Replacing the fuse .....	67		
Towing the watercraft .....	68		
Submerged watercraft .....	69		

# General and important labels

EJU36452

## Identification numbers

Record the Primary Identification (PRI-ID) number, Craft Identification Number (CIN), and engine serial number in the spaces provided for assistance when ordering spare parts from a Yamaha dealer. Also record and keep these ID numbers in a separate place in case your watercraft is stolen.

EJU30272

### Primary Identification (PRI-ID) number

The PRI-ID number is stamped on a plate attached inside the engine compartment. (See page 23 for hood removal and installation procedures.)

#### MODEL:

SJ700B-U (SuperJet)

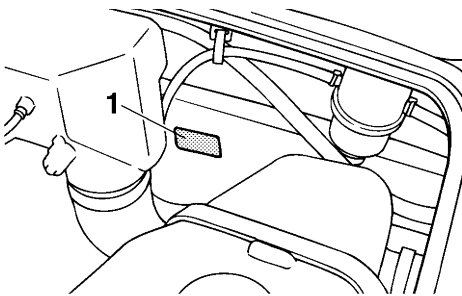

1 Primary Identification (PRI-ID) number location

MODEL	<input type="text"/>
PRI-ID	<input type="text"/>
F4D	<input type="text"/>
YAMAHA MOTOR CO., LTD	
MADE IN JAPAN	
PAYS D'ORIGINE JAPON	

F	4	D	-	<input type="text"/>	<input type="text"/>	<input type="text"/>	<input type="text"/>	<input type="text"/>	<input type="text"/>	<input type="text"/>
---	---	---	---	----------------------	----------------------	----------------------	----------------------	----------------------	----------------------	----------------------

EJU36461

### Craft Identification Number (CIN)

The CIN is stamped on a plate attached to the hull on the aft, starboard (right) side.

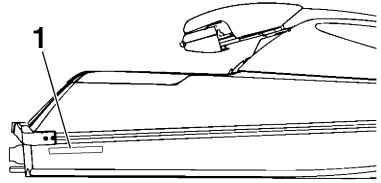

1 Craft Identification Number (CIN) location

J	P	-	Y	A	M	<input type="text"/>	<input type="text"/>	<input type="text"/>	<input type="text"/>	<input type="text"/>	<input type="text"/>	<input type="text"/>	<input type="text"/>	<input type="text"/>	<input type="text"/>	<input type="text"/>	<input type="text"/>
---	---	---	---	---	---	----------------------	----------------------	----------------------	----------------------	----------------------	----------------------	----------------------	----------------------	----------------------	----------------------	----------------------	----------------------

EJU40641

### Engine serial number

The engine serial number is stamped on a plate attached to the engine unit. (See page 23 for hood removal and installation procedures.)

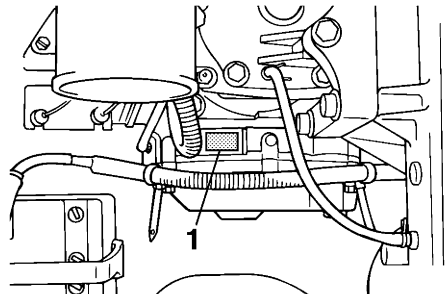

1 Engine serial number location

<b>YAMAHA</b>		<input type="text"/>
<input type="text"/>	<input type="text"/>	<input type="text"/>
<b>YAMAHA MOTOR CO., LTD.</b>		
<b>MADE IN JAPAN</b>		
<b>PAYS D'ORIGINE JAPON</b>		

# General and important labels

---

EJU41742

## Manufactured date label

This label is attached to the muffler. (See page 23 for hood removal and installation procedures.)

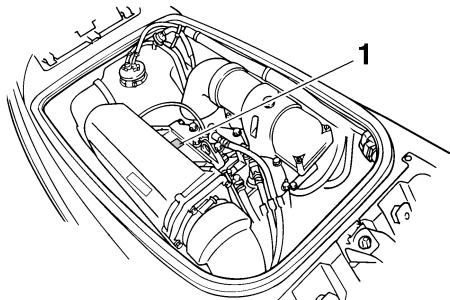

1 Manufactured date label location

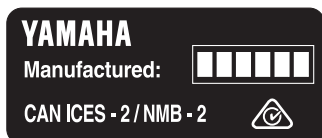



# General and important labels

EJU30453

## Important labels

Read the following labels before using this watercraft. If have any questions, consult a Yamaha dealer.

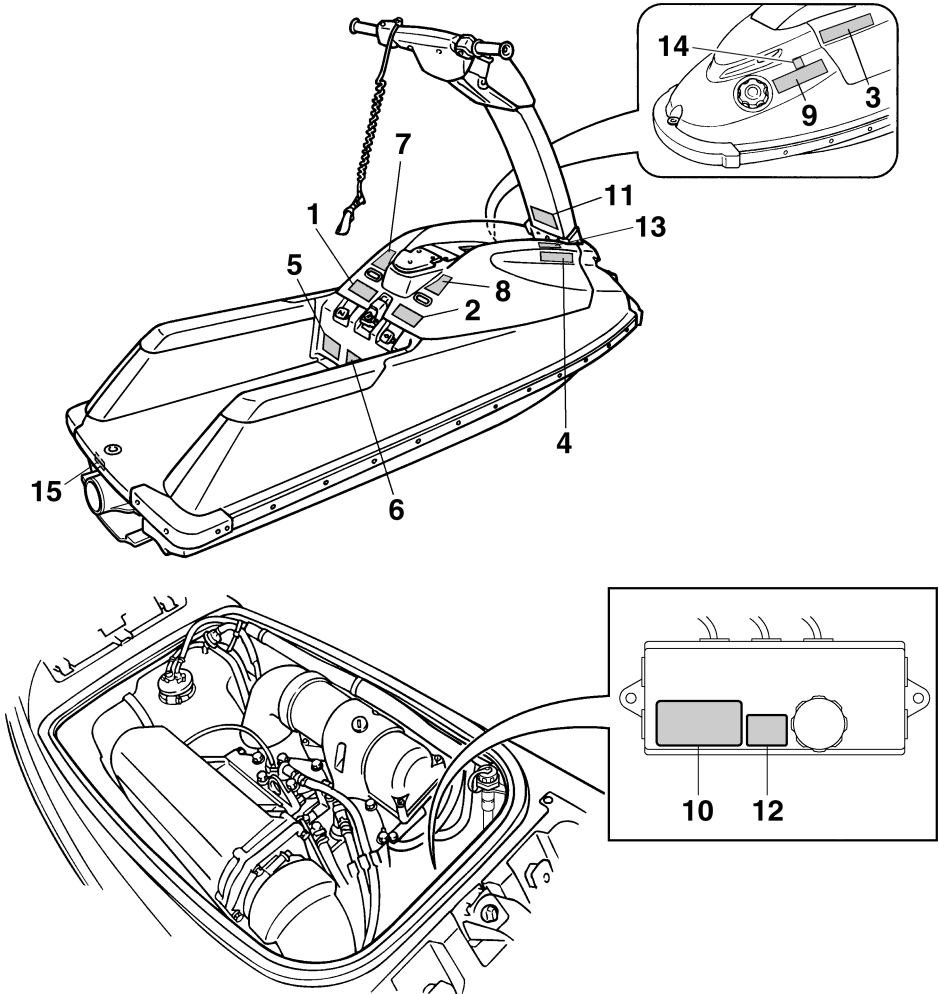

# General and important labels

EJU35914

## Warning labels

If any of these labels are damaged or missing, contact a Yamaha dealer for replacements.

1

**⚠ WARNING**

To reduce the risk of **SEVERE INJURY** or **DEATH**:  
**WEAR A PERSONAL FLOTATION DEVICE (PFD)**. All riders must wear an authority-approved PFD that is suitable for personal watercraft (PWC) use.

**WEAR PROTECTIVE CLOTHING**. Severe internal injuries can occur if water is forced into body cavities as a result of falling into water or being near jet thrust nozzle. Normal swimwear does not adequately protect against forceful water entry into rectum or vagina. All riders must wear a wet suit bottom or clothing that provides equivalent protection. (See Owner's Manual.) Footwear, gloves, and goggles/glasses are recommended.

**KNOW BOATING LAWS**. Yamaha Motor Co., Ltd. recommends a minimum operator age of 16 years old. Know the operator age and training requirements for your state. A boating safety course is recommended and may be required in your state.

**ATTACH ENGINE SHUT-OFF CORD (LANYARD)** to wrist and keep it free from handrails so that engine stops if operator falls off. After riding, remove cord from PWC to avoid unauthorized use by children or others.

continued on label to the right



GM6-641B1-01

2

**⚠ WARNING**

continued

**RIDE WITHIN YOUR LIMITS** and **AVOID AGGRESSIVE MANEUVERS** to reduce the risk of loss of control, ejection, and collision. This is a high performance boat - not a toy. Sharp turns or jumping wakes or waves can increase the risk of back/spinal injury (paralysis), facial injuries, and broken legs, ankles, and other bones. Do not jump wakes or waves.

**DO NOT APPLY THROTTLE WHEN OTHERS ARE AT REAR OF PWC**-turn engine off or keep engine at idle. Water and/or debris exiting jet thrust nozzle can cause severe injury.

**KEEP AWAY FROM INTAKE GRATE** while engine is on. Items such as long hair, loose clothing, or PFD straps can become entangled in moving parts resulting in severe injury or drowning.

**AVOID FORCEFUL JET THRUST AND LIMITED VISIBILITY WHILE REBOARDING**. Get to standing or kneeling position quickly, but do not expose yourself to forceful jet thrust.

**NEVER RIDE AFTER CONSUMING DRUGS OR ALCOHOL**.

**READ AND FOLLOW OWNER'S MANUAL**



GM6-641B1-10

3

**⚠ AVERTISSEMENT**

*Afin de limiter les risques de BLESSURES GRAVES, voire MORTELLES: PORTER UN GILET DE SAUVETAGE. Tout utilisateur doit porter un gilet de sauvetage homologué pour les scooters des mers.*

**PORTER DES VÊTEMENTS PROTECTEURS**. Le choc infligé par la pénétration forcée d'eau dans les orifices corporels lors d'une chute ou lors du contact avec le jet d'eau de la pompe risque de provoquer des lésions graves. Le port d'un simple maillot de bain ne constitue pas une protection adéquate contre la puissance de pénétration de l'eau dans le rectum et/ou le vagin. Tout utilisateur doit porter le pantalon d'une tenue de plongée ou tout autre vêtement offrant une protection semblable. (Voir le manuel d'utilisation.)

*Le port de chaussures, de gants et de lunettes de plongée est recommandé.*

**CONNAÎTRE LES LOIS DE NAVIGATION**. La Yamaha Motor Co., Ltd. recommande la limite d'âge de pilotage de 16 ans. Vérifier l'âge du pilote ainsi que les exigences quant à l'âge prévues par la législation locale. Il est préférable, et parfois requis par certaines législations, de suivre un cours de sécurité maritime.

**ATTACHER LA LANIÈRE DE L'INTERRUPTEUR D'ARRÊT DU MOTEUR** au poignet et l'éloigner du guidon afin que le moteur se coupe bien en cas de chute. Après utilisation, retirer la lanière du scooter afin de prévenir toute utilisation par des enfants ou des personnes non-autorisées. *Suite sur l'étiquette de droite*



GM6-641B1-41

4

**⚠ AVERTISSEMENT**

*Suite*

**RESPECTER SES LIMITES ET ÉVITER LES MANOEUVRES BRUTALES** afin de limiter tout risque de perte de contrôle, d'éjection et de collision. Il s'agit d'un véhicule à hautes performances et pas d'un jouet. Des virées brusques ou le saut de sillages ou de vagues accroît le risque de blessures au dos, voire de paralysie, de blessures au visage et de fractures diverses. Ne jamais sauter des sillages ni des vagues.

**NE PAS DONNER DES GAZ LORSQUE DES PERSONNES SE TROUVENT DERRIÈRE LE VÉHICULE**: couper le moteur ou laisser tourner au ralenti. Eau et/ou débris projetés par la pompe pourraient causer des blessures graves.

**NE PAS S'APPROCHER DE LA GRILLE D'ADMISSION** lorsque le moteur tourne.

*Cheveux longs, vêtements amples ou lanières de gilet de sauvetage risquent d'être happés, ce qui pourrait provoquer des blessures, ou même une noyade.*

**ÉVITER LES POUSSÉES PUISSANTES ET LA MAUVAISE VISIBILITÉ LORS DU RÉEMBARQUEMENT**. Se mettre rapidement debout ou à genoux, tout en veillant à ne pas s'exposer à un jet puissant.

**NE JAMAIS PILOTER APRÈS AVOIR ABSORBÉ DE L'ALCOOL, DES DROGUES OU CERTAINS MÉDICAMENTS.**

**LIRE ET RESPECTER LES INSTRUCTIONS DONNÉES DANS LE MANUEL D'UTILISATION.**



GM6-641B1-50

# General and important labels

5

**⚠ WARNING**

Collisions result in more **INJURIES AND DEATHS** than any other type of accident for personal watercraft (PWC).

**TO AVOID COLLISIONS:**

**SCAN CONSTANTLY** for people, objects, and other watercraft. Be alert for conditions that limit your visibility or block your vision of others.

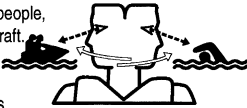

**OPERATE DEFENSIVELY** at safe speeds and keep a safe distance away from people, objects, and other watercraft.

- Do not follow directly behind PWCs or other boats.
- Do not go near others to spray or splash them with water.
- Avoid sharp turns or other maneuvers that make it hard for others to avoid you or understand where you are going.
- Avoid areas with submerged objects or shallow water.

continued on label to the right

YAMAHA GM6-641B2-00

6

**⚠ WARNING**

continued

**TAKE EARLY ACTION** to avoid collisions. Remember, PWCs and other boats do not have brakes.

**DO NOT RELEASE THROTTLE WHEN TRYING TO STEER** away from objects - you need throttle to steer. Always check throttle and steering controls for proper operation before starting PWC.

Follow navigation rules and state/province and local laws that apply to PWCs.

See Owner's Manual for more information.

YAMAHA GM6-641B2-10

7

**⚠ AVERTISSEMENT**

*Les collisions sont la cause principale des BLESSURES ET DÉCÈS d'utilisateurs de scooter des mers.*

**POUR ÉVITER LES COLLISIONS: ÉTRE CONSTAMMENT à l'affût de personnes, d'objets et d'autres bateaux. Être conscient des conditions limitant sa visibilité ou celle des autres embarcations. PILOTER AVEC PRUDENCE à des vitesses raisonnables et garder une distance de sécurité entre le scooter et toute personne, objet et embarcation.**



Suite sur l'étiquette de droite

YAMAHA GM6-641B2-40

8

**⚠ AVERTISSEMENT**

*Suite*

- Ne pas suivre une autre embarcation de trop près.
- Ne pas se rapprocher d'autrui en vue de l'éclabousser.
- Éviter les virages brusques ou toute manoeuvre qui risque de mettre un autre pilote en danger ou qui l'empêche de pouvoir déterminer clairement la direction que l'on prend.
- Éviter les endroits où flottent des objets et les eaux peu profondes.

**RÉAGIR RAPIDEMENT** en vue d'éviter les collisions. Garder à l'esprit que les bateaux n'ont pas de freins.

**NE PAS LÂCHER LES GAZ LORSQUE L'ON ESSAYE DE S'ÉLOIGNER** d'objets - une poussée est nécessaire à la direction du scooter des mers. Toujours s'assurer avant le départ que l'accélérateur et la direction fonctionnent correctement. Suivre les lois de navigation ainsi que les législations nationales, provinciales et locales concernant les scooters des mers.

Voir le manuel d'utilisation pour plus d'informations.

YAMAHA GM6-641B2-50

# General and important labels



9

<p><b>⚠ WARNING</b></p> <p>Gasoline is highly flammable and explosive. A fire or explosion could cause severe injury or death. Shut engine off. Refuel in well ventilated area away from flames or sparks. Do not smoke. Avoid spilling gasoline. Wipe up spilled gasoline immediately. Open hood to ventilate fuel vapors from engine compartment before starting engine. Do not start engine if there is a fuel leak or a loose electrical connection.</p>	<p><b>⚠ AVERTISSEMENT</b></p> <p><i>L'essence est très inflammable et explosible. Un incendie ou une explosion risquent de provoquer des blessures graves, voire mortelles. Couper le moteur. Faire le plein dans un endroit bien aéré et éloigné de toute flamme ou étincelle. Ne pas fumer. Éviter de renverser de l'essence. Essuyer immédiatement toute coulure d'essence. Ouvrir le capot pour évacuer les vapeurs d'essence du compartiment du moteur avant de mettre le moteur en marche. Ne jamais mettre le moteur en marche en cas de fuite d'essence ou si un branchement électrique est desserré.</i></p>
<p><b>GASOLINE AND OIL MIXING RATIO : 50:1</b></p>	<p><b>RAPPORT DE MELANGE D'ESSENCE ET D'HUILE : 50:1</b></p>
<p>YAMAHA</p>	<p>F1N-6415B-10</p>

10

<p><b>⚠ WARNING / AVERTISSEMENT / 警告</b></p>
<p>Do not touch or remove electrical parts when starting or running the engine.</p>
<p>Ne pas toucher ou retirer les pièces électriques lors du démarrage ou de la marche du moteur.</p>
<p>運転中は電装品には触らないでください。</p>
<p>YAMAHA <span style="float: right;">696-83823-00</span></p>

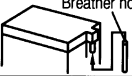
11

<p><b>⚠ WARNING</b></p> <p>Be sure to connect breather hose to battery. Fire or explosion could result if not connected properly.</p>	<p>Breather hose</p> 
<p><b>⚠ AVERTISSEMENT</b></p> <p><i>Bien veiller à brancher la durit de mise à l'air à la batterie. Un mauvais branchement risque d'être à l'origine d'un incendie ou d'une explosion.</i></p>	<p>Mise à l'air</p> 
<p>YAMAHA</p>	
<p>F1N-641DB-10</p>	

# General and important labels

EJU35927

## Other labels

12

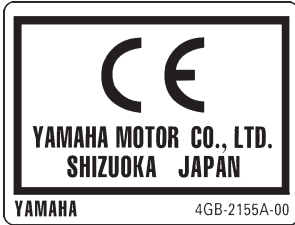

13



14



The following label indicates the correct direction to upright a capsized watercraft.

15

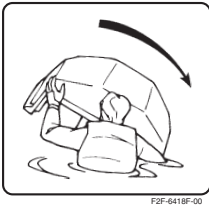

# Safety information

---

EJU30683

The safe use and operation of this watercraft is dependent upon the use of proper riding techniques, as well as upon the common sense, good judgment, and expertise of the operator. Before using this watercraft, make sure that its use is permitted under local laws, bylaws, and regulations, and always operate the watercraft in full conformity with any requirements and limitations imposed. Every operator should know the following requirements before riding the watercraft.

- Before operating the watercraft, read this owner's/operator's manual, the Riding Practice Guide, the Riding Instruction card, and all labels on the watercraft. These materials should give you an understanding of the watercraft and its operation.
- Never allow anyone to operate this watercraft until they too have read this owner's/operator's manual, the Riding Practice Guide, the Riding Instruction card, and all labels.

EJU30701

## Limitations on who may operate the watercraft

- Yamaha recommends a minimum operator age of 16 years old. Adults must supervise use by minors. Know your local operator age and training requirements.
- This watercraft is designed to carry the operator only. Never have more than one person on the watercraft at any time.



EJU30762

## Cruising limitations

- Scan constantly for people, objects, and other watercraft. Be alert for conditions that limit your visibility or block your vision of others.

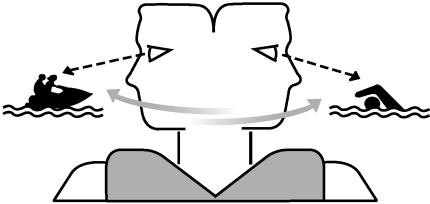

- Operate defensively at safe speeds and keep a safe distance away from people, objects, and other watercraft.
- Do not follow directly behind watercraft or other boats.
- Do not go near others to spray or splash them with water.
- Avoid sharp turns or other maneuvers that make it hard for others to avoid you or understand where you are going.
- Avoid areas with submerged objects or shallow water.
- Take early action to avoid collisions. Remember, watercraft and other boats do not have brakes.
- Do not release the throttle lever when trying to steer away from objects—you need throttle to steer. Always check throttle and steering controls before starting the watercraft.
- Ride within your limits and avoid aggressive maneuvers to reduce the risk of loss of control, ejection, and collision.
- This is a high performance boat—not a toy. Sharp turns or jumping wakes or waves can increase the risk of back/spinal injury

(paralysis), facial injuries, and broken legs, ankles, and other bones. Do not jump wakes or waves.

- Do not operate the watercraft in rough water, bad weather, or when visibility is poor; this may lead to an accident causing injury or death. Be alert to the possibility of adverse weather. Take note of weather forecasts and the prevailing weather conditions before setting out on your watercraft.
- As with any water sport, you should not operate your watercraft without someone else nearby. If you operate further than swimming distance from shore, you should be accompanied by another boat or watercraft, but make sure you stay a safe distance away. It's good, common sense.
- Never operate in water that is less than 60 cm (2 ft) deep from the bottom of the watercraft, otherwise you increase your chance of hitting a submerged object, which could result in injury.

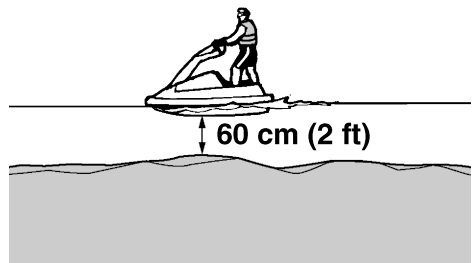

- This watercraft is not equipped with lighting required for night operation. Do not operate the watercraft after sunset or before dawn, otherwise you increase the risk of

## Safety information

colliding with another boat, which could result in severe injury or death.



- Follow navigation rules, and state/provincial and local laws that apply to watercraft.

EJU30782

### Operation requirements

- All riders must wear a personal flotation device (PFD) that is approved by the appropriate authorities and is suitable for personal watercraft use.
- Wear protective clothing. Severe internal injuries can occur if water is forced into body cavities as a result of falling into the water or being near the jet thrust nozzle. Normal swimwear does not adequately protect against forceful water entry into the rectum or vagina. All riders must wear a wetsuit bottom or clothing that provides equivalent protection. Such clothing includes thick, tightly woven, sturdy and snug-fitting apparel such as denim, but does not include spandex or similar fabrics, like those used in bicycle shorts.

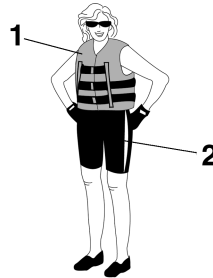

- 1 Authority-approved PFD
- 2 Wetsuit bottom

- Eye protection is recommended to keep wind, water, and glare from the sun out of your eyes while you operate your watercraft. Restraining straps for eyewear are made which are designed to float should your eyewear fall in the water. Footwear and gloves are recommended.
- You must decide whether to wear a helmet while you ride for recreation. You should know that a helmet could help protect you



in certain kinds of accidents and that it could injure you in others.

A helmet is designed to provide some head protection. Although helmets cannot protect against all foreseeable impacts, a helmet might reduce your injuries in a collision with a boat or other obstacle.

A helmet may have potential safety hazards, as well. Falling into the water could risk the chance of the helmet catching water, commonly known as “bucketing”, and the resulting strain on your neck could cause choking, severe and permanent neck injuries, or death. A helmet could also increase the risk of an accident if it reduces your vision or hearing, or if it distracts you or increases your fatigue.

How should you decide if a helmet’s potential safety benefits outweigh its potential risks for you? Consider your particular riding conditions. Consider factors such as your riding environment and your riding style and ability. Also consider the likelihood of traffic congestion, and the water surface conditions.

If you decide to wear a helmet based upon your riding circumstances, choose one carefully. Look for a helmet designed for personal watercraft use, if possible. If you will be engaging in closed-course competition, follow the helmet requirements of the sanctioning organization.

- Never operate the watercraft after consuming alcohol or taking other drugs.
- For reasons of safety and proper care of the watercraft, always perform the pre-operation checks listed on page 33 before operating the watercraft.
- The operator should always keep both feet or knees on the riding tray when the watercraft is in motion. Lifting your feet increases

the chances of losing your balance or hitting objects outside the watercraft with your feet.



- Always consult your doctor on whether it is safe for you to operate this watercraft if you are pregnant or in poor health.
- Do not attempt to modify this watercraft. Modifications to your watercraft may reduce safety and reliability, and render the watercraft unsafe or illegal for use.
- Attach the engine shut-off cord (lanyard) to your left wrist and keep it free from the handlebars so that the engine stops if you, the operator, fall off. After riding, remove the engine shut-off cord (lanyard) from the watercraft to avoid accidental starting or unauthorized use by children or others.

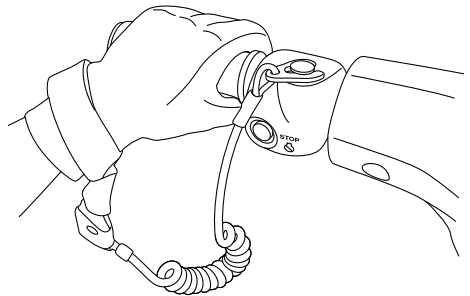

- Scan carefully for swimmers, and stay away from swimming areas. Swimmers are hard to see and you could accidentally hit someone in the water.

## Safety information

---

- Avoid being hit by another boat. You should always take the responsibility to watch for traffic; other boaters may not be watching for you. If they do not see you, or if you maneuver more quickly than other boaters expect, you risk a collision.
- Maintain a safe distance from other boats and watercraft, and also watch for ski ropes or fishing lines. Obey the “Safe boating rules” and be sure to check behind you before making a turn. (See “Safe boating rules” on page 14.)

EJU30841

### **Recommended equipment**

The following items should be carried on board your watercraft:

- **Sound-signaling device**  
You should carry a whistle or other sound-signaling device that can be used to signal other boats.
- **Visual distress signals**  
It is recommended that a pyrotechnic device, which is approved by the appropriate authorities, be stored in a waterproof container on your watercraft. A mirror can also be used as an emergency signal. Contact a Yamaha dealer for more information.
- **Watch**  
A watch is helpful so you will know how long you have been operating the watercraft.
- **Towline**  
A towline can be used to tow a disabled watercraft in an emergency.

EJU30851

### Hazard information

- When transporting or storing your watercraft, always turn the fuel cock knob to “OFF”, otherwise gasoline may overflow from the carburetor.

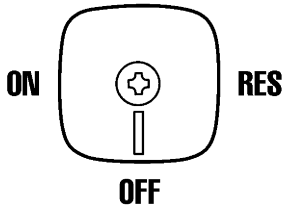

- Never start the engine or let it run for any length of time in an enclosed area. Exhaust fumes contain carbon monoxide, a colorless, odorless gas that may cause loss of consciousness and death within a short time. Always operate the watercraft in an open area.

EJU30881

### Watercraft characteristics

- Jet thrust turns the watercraft. Releasing the throttle lever completely produces only minimum thrust. If you are traveling at speeds above trolling, you will have rapidly decreasing ability to steer without throttle. You may still have some turning ability immediately after releasing the throttle lever, but once the engine slows down, the watercraft will no longer respond to handlebar input until you apply throttle again or you reach trolling speed.

Practice turning in an open area without obstacles until you have a good feel for this maneuver.

- This watercraft is water-jet propelled. The jet pump is directly connected to the engine. This means that jet thrust will produce some movement whenever the engine is running. There is no “neutral” position.
- Keep away from the intake grate while the engine is on. Items such as long hair, loose clothing, or PFD straps can become entangled in moving parts, resulting in severe injury or drowning.
- Never insert any object into the jet thrust nozzle while the engine is running. Severe injury or death could result from coming in

# Safety information

contact with the rotating parts of the jet pump.

EJU30971

## Safe boating rules

Your Yamaha watercraft is legally considered a powerboat. Operation of the watercraft must be in accordance with the rules and regulations governing the waterway on which it is used.

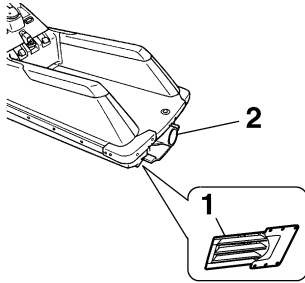

- 1 Intake grate
- 2 Jet thrust nozzle

- Stop the engine and remove the clip from the engine shut-off switch before removing any debris or weeds, which may have collected around the jet intake.

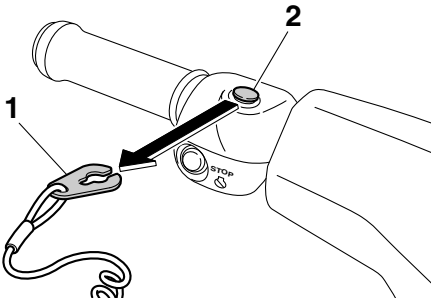

- 1 Clip
- 2 Engine shut-off switch

- Avoid forceful jet thrust and limited visibility while reboarding. Get to a standing or kneeling position quickly, but do not expose yourself to the forceful jet thrust.

EJU30992

## **Enjoy your watercraft responsibly**

You share the areas you enjoy when riding your watercraft with others and with nature. So your enjoyment includes a responsibility to treat these other people, and the lands, waters, and wildlife with respect and courtesy.

Whenever and wherever you ride, think of yourself as the guest of those around you. Remember, for example, that the sound of your watercraft may be music to you, but it could be just noise to others. And the exciting splash of your wake can make waves others won't enjoy.

Avoid riding close to shoreline homes and waterfowl nesting areas or other wildlife areas, and keep a respectful distance from fishermen, other boats, swimmers, and populated beaches. When travel in areas like these is unavoidable, ride slowly and obey all laws.

Proper maintenance is necessary to ensure that the exhaust emission and sound levels of your watercraft will continue to be within regulated limits. You have the responsibility to make sure that the recommended maintenance in this owner's/operator's manual is carried out.

Remember, pollution can be harmful to the environment. Do not refuel or add oil where a spill could cause damage to nature. Remove your watercraft from the water and move it away from the shoreline before refueling. Dispose of water and any fuel and oil residue in the engine compartment according to local regulations. And keep your surroundings pleasant for the people and wildlife that share the waterways: don't litter.

When you ride responsibly, with respect and courtesy for others, you help ensure that our waterways stay open for the enjoyment of a variety of recreational opportunities.

# Description

---

EJU40653

## Watercraft glossary

### **Trolling speed**

“Trolling” is the lowest maneuvering speed. You are applying little or no throttle. The watercraft is down in the water, and there is no wake.

### **Sub-planing speed**

“Sub-planing” is a medium speed. The bow of the watercraft is slightly up from the water surface, but you are still traveling through the water. There is a wake.

### **Planing speed**

“Planing” is a faster speed. The watercraft is more level and is skimming on top of the water. There is a wake.

### **Bow**

The front end of the watercraft.

### **Stern**

The rear end of the watercraft.

### **Starboard**

The right side of the watercraft when facing forward.

### **Port**

The left side of the watercraft when facing forward.

### **Bilge water**

Water that has collected in the engine compartment.

EJU31012

## Location of main components

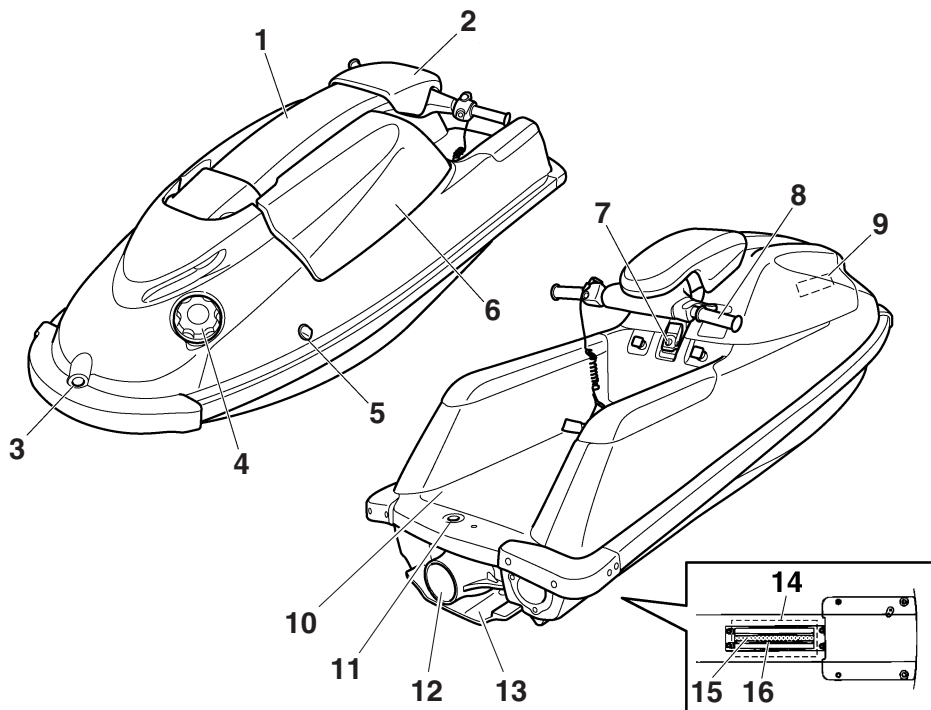

- 1 Steering pole
- 2 Steering pole cover
- 3 Bow rope hole
- 4 Fuel filler cap
- 5 Cooling water pilot outlet
- 6 Hood
- 7 Hood latch
- 8 Handlebar
- 9 Storage pouch
- 10 Riding tray
- 11 Stern rope hole
- 12 Jet thrust nozzle
- 13 Ride plate
- 14 Jet intake
- 15 Drive shaft
- 16 Intake grate

# Description

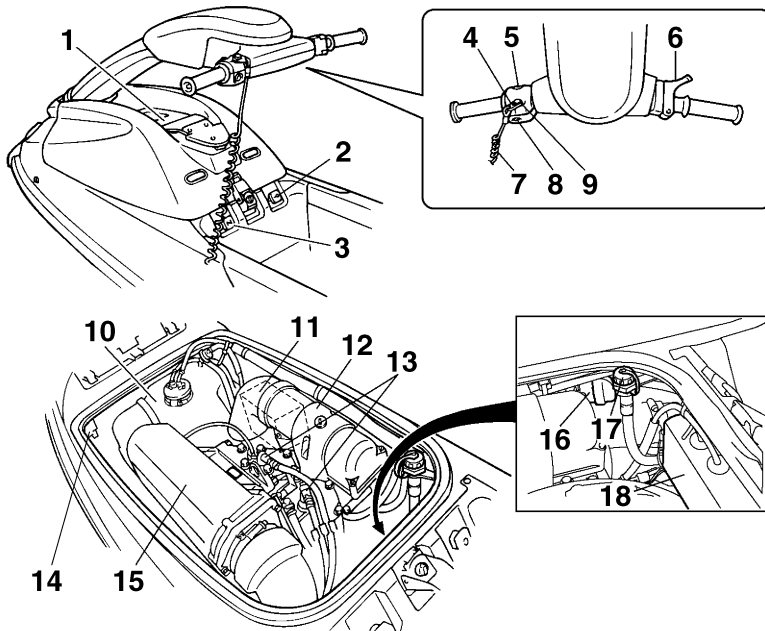

- 1 Fire extinguisher container
- 2 Fuel cock knob
- 3 Choke knob
- 4 Clip
- 5 Start switch
- 6 Throttle lever
- 7 Engine shut-off cord (lanyard)
- 8 Engine stop switch
- 9 Engine shut-off switch
- 10 Fuel tank
- 11 Battery
- 12 Silencer
- 13 Spark plug/Spark plug cap
- 14 Water separator
- 15 Muffler
- 16 Fuel filter
- 17 Flushing hose connector (page 50)
- 18 Electrical box



# Control function operation

EJU31026

## Watercraft control functions

EJU31153

### Engine stop switch “”

The engine stop switch (red button) stops the engine when the switch is pushed.

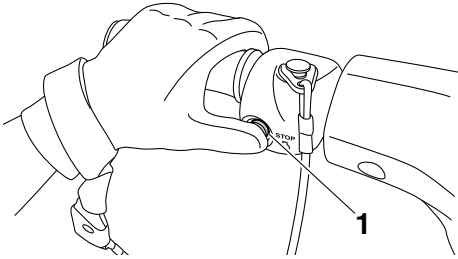

1 Engine stop switch

EJU31164

### Engine shut-off switch “”

The engine shut-off switch automatically stops the engine when the clip, on the end of the engine shut-off cord (lanyard), is removed from the switch, such as if the operator falls off the watercraft.

Insert the clip under the engine shut-off switch before starting the engine.

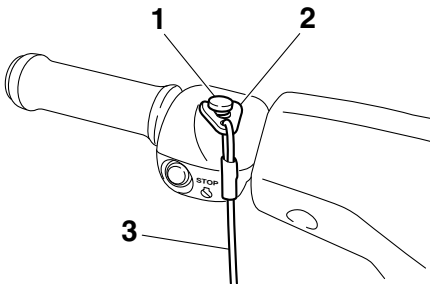

- 1 Engine shut-off switch
- 2 Clip
- 3 Engine shut-off cord (lanyard)

When the engine is not running, remove the clip from the engine shut-off switch to pre-

vent accidental starting or unauthorized operation by children or others.

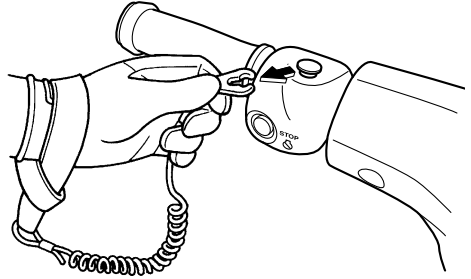

EJU41051

### Start switch “”

ECJ01361

#### **NOTICE**

**Do not run the engine for more than 15 seconds on land without supplying water, otherwise the engine could overheat.**

The start switch (green button) starts the engine when the switch is pushed.

Release the start switch as soon as the engine starts to run. If the engine does not start in 5 seconds, release the start switch, wait 15 seconds, and then try again. **NOTICE: Never push the start switch while the engine is running. Do not operate the start switch for more than 5 seconds, otherwise the battery will be discharged and the engine**

# Control function operation

**will not start. Also, the starter motor could be damaged.** [ECJ01041]

zle is changed, and the direction of the watercraft is changed accordingly.

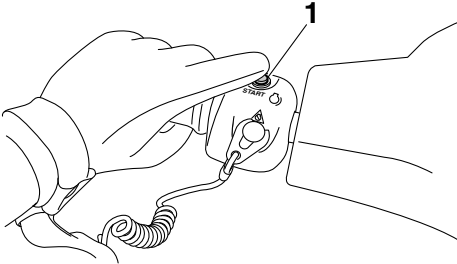

1 Start switch

The engine will not start when the clip is removed from the engine shut-off switch.

EJU31212

## Throttle lever

The throttle lever increases the engine speed when the lever is squeezed.

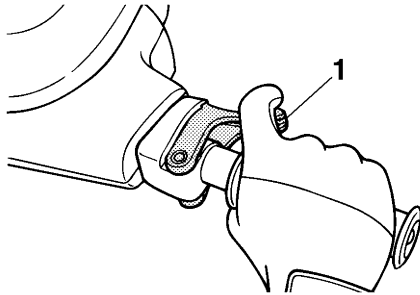

1 Throttle lever

The throttle lever returns automatically to its fully closed (idle) position when released.

EJU35933

## Steering system

By turning the handlebars in the direction you wish to travel, the angle of the jet thrust nozzle

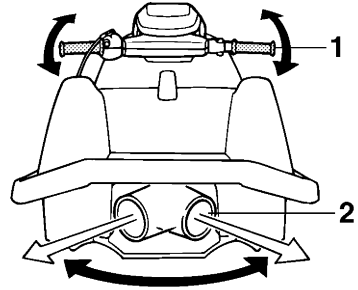

1 Handlebar

2 Jet thrust nozzle

Since the strength of the jet thrust determines the speed and degree of a turn, throttle must always be applied when attempting a turn, except at trolling speed.

The angle of the jet thrust nozzle can be adjusted to suit operator preference. (See page 57 for information on adjusting the jet thrust nozzle angle.)

EJU31273

## Steering pole

The steering pole can be moved up or down to change the height of the handlebars.

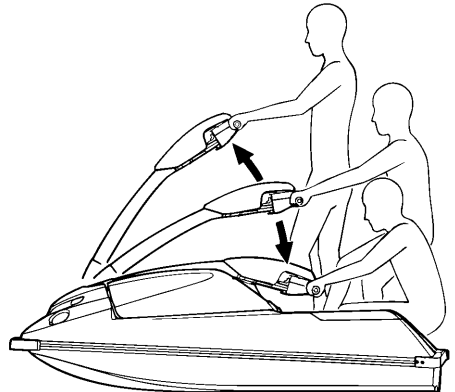

# Control function operation

EJU31124

## Fuel cock knob

The fuel supply method can be switched by operating the fuel cock knob.

Select the fuel cock knob position from the following three positions according to the circumstances of use.

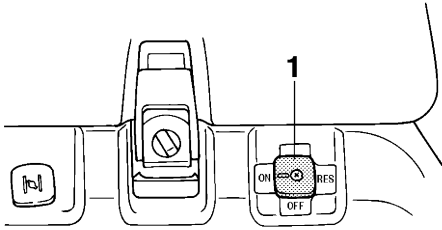

1 Fuel cock knob

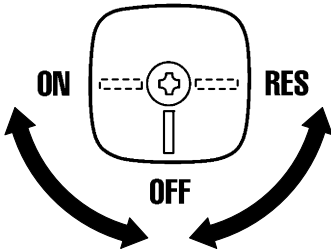

### OFF:

With the fuel cock knob in this position, fuel does not flow to the carburetors. Always turn the fuel cock knob to this position when the engine is not running.

### ON:

With the fuel cock knob in this position, fuel flows to the carburetors. Turn the fuel cock knob to this position when starting the engine and operating the watercraft.

### RES:

With the fuel cock knob in this position, the fuel reserve is made available. Turn the fuel cock knob to this position if you run out of

fuel while operating the watercraft. When this occurs, refuel as soon as possible and be sure to turn the fuel cock knob back to “ON”.

EJU31203

## Choke knob “”

The choke knob can be operated to supply a richer air-fuel mixture that is required to start a cold engine.

To use the choke:

Push the choke knob out.

Push the choke knob in to stop using the choke after the engine starts.

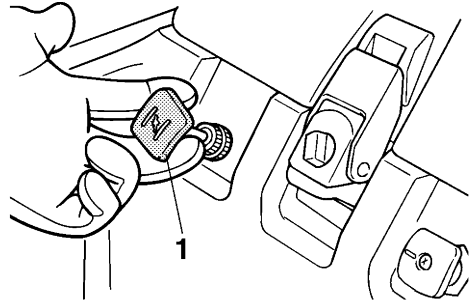

1 Choke knob

EJU31224

## Cooling water pilot outlet

When the engine is running, some of the cooling water that is circulated in the engine is discharged from the cooling water pilot outlet.

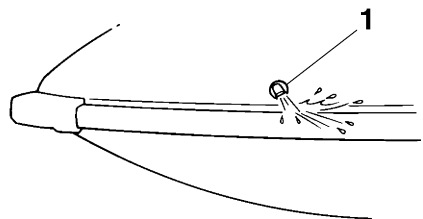

1 Cooling water pilot outlet

There is a cooling water pilot outlet on the port (left) side of the watercraft. To check for

# Control function operation

proper operation of the cooling system, make sure that water is being discharged from the cooling water pilot outlet. If water is not being discharged from the outlet, stop the engine and check the jet intake for clogging. (See page 66 for information on the jet intake.)

## TIP:

- It will take about 20 seconds for the water to reach the outlet after the engine is started.
- Water discharge may not be constant when the engine is running at idling speed. If this occurs, apply a little throttle to make sure that water discharges properly.

EJU40323

## Water separator

The water separator prevents water from entering the fuel tank by collecting any water that has entered the fuel tank breather hose if the watercraft was capsized.

If water has collected in the water separator, drain it by loosening the drain screw.

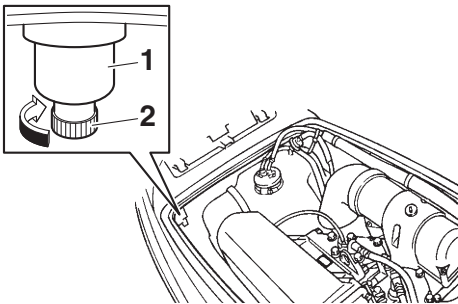

- 1 Water separator
- 2 Drain screw

### To drain water from the water separator:

- (1) Place a drain pan or dry cloth under the water separator.
- (2) Gradually loosen the drain screw to drain the water. Catch the draining water in the drain pan or soak it up with the dry cloth so that it does not spill into the engine compartment. If any water spills into the

watercraft, be sure to wipe it up with a dry cloth.

- (3) Securely tighten the drain screw until it stops.

EJU31665

## Engine overheat warning system

If the engine temperature rises significantly, the engine overheat warning system will activate and the engine speed will be limited to about 3400 r/min to help prevent damage.

If the engine overheat warning system is activated, immediately reduce the engine speed, return to shore, and then make sure that water is being discharged from the cooling water pilot outlet while the engine is running. If there is no discharge of water, stop the engine, and then check the jet intake for clogging. (See page 66 for information on the jet intake.) **NOTICE: If you cannot locate and correct the cause of the overheating, consult a Yamaha dealer. Continuing to operate at higher speeds could result in severe engine damage.** [ECJ00042]

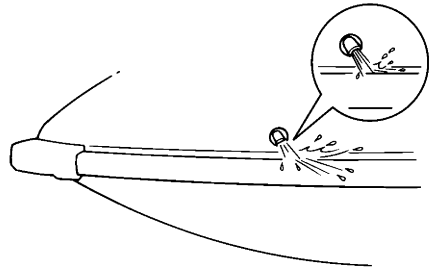

EJU40334

## Equipment

EJU31057

### Hood

The hood is removable.

Remove the hood to access the engine compartment.

To remove the hood:

- (1) Lift the steering pole and support it with the lock pin.

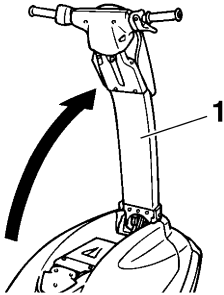

1 Steering pole

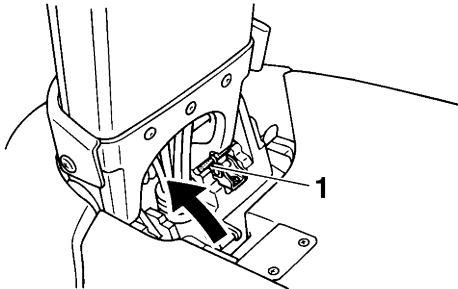

1 Lock pin

- (2) Turn the latch knob to the "OPEN" position, and then pull up on the hood latch to unlatch the hood.

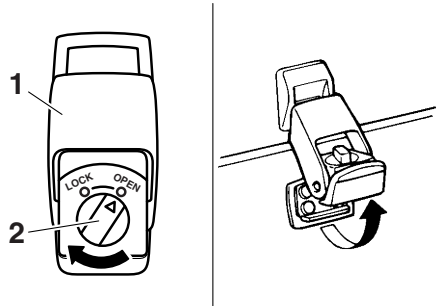

- 1 Hood latch
- 2 Hood latch knob

- (3) Grasp the hood using the handgrips provided at the front and rear of the hood. Lift the hood up and to the rear to remove it.

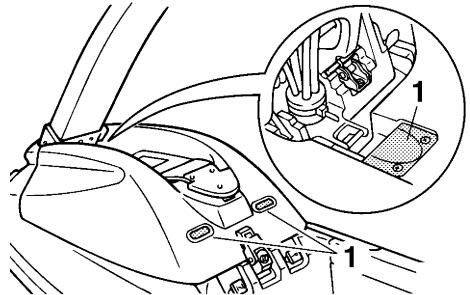

1 Handgrip

# Equipment operation

To install the hood:

- (1) Position the hood on the deck so that the two projections at the front of the hood fit under the two stays on the deck.

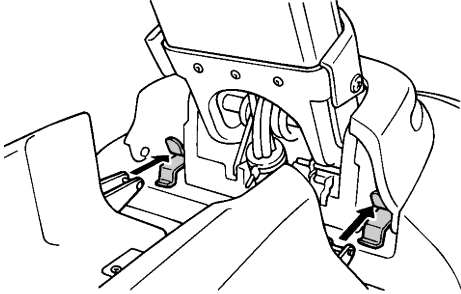

- (2) Push down on the hood latch, and then turn the knob to the "LOCK" position to securely lock the hood in place.

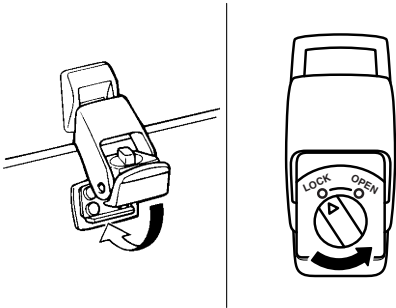

- (3) While holding the steering pole, move the lock pin to the stowed position, and then lower the steering pole.

EJU36003

## Bow rope hole

The bow rope hole is used to attach a rope to the watercraft when transporting, mooring, or

towing it in an emergency. (See page 68 for information on towing the watercraft.)

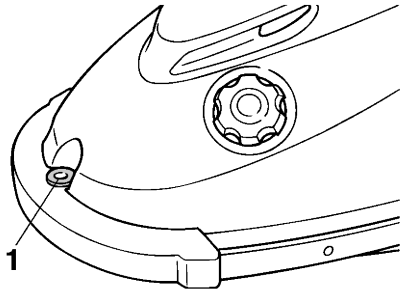

1 Bow rope hole

EJU36012

## Stern rope hole

The stern rope hole is used to attach a rope to the watercraft when mooring it.

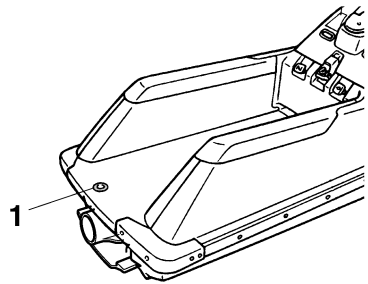

1 Stern rope hole

EJU31676

## Storage pouch

The storage pouch is located on the bottom of the hood.

Use the storage pouch to store the owner's/operator's manual, tool kit, and other small items. The storage pouch is not designed to be waterproof. If you carry objects that must be kept dry, put them in a waterproof bag.

To remove the storage pouch:

- (1) Remove the hood. (See page 23 for hood removal and installation procedures.)

# Equipment operation

- (2) Unfasten the bands, and then remove the storage pouch.

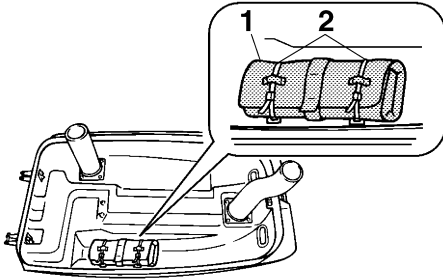

- 1 Storage pouch  
2 Band

## To install the storage pouch:

- (1) Bend the owner's/operator's manual slightly to insert it into the storage pouch, and then add the tool kit and any other small items. Fold the pouch, and then wrap the strap around it.

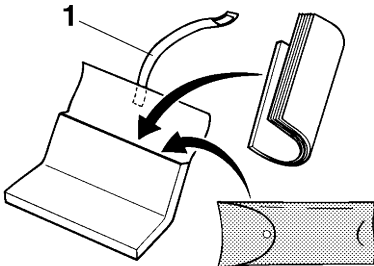

- 1 Strap
- (2) Install the storage pouch on the hood and secure it with the bands.
- (3) Securely install the hood in its original position.

EJU41004

## Fire extinguisher container

The fire extinguisher container is located on the hood.

## To open the fire extinguisher container:

- (1) Lift the steering pole and support it with the lock pin.

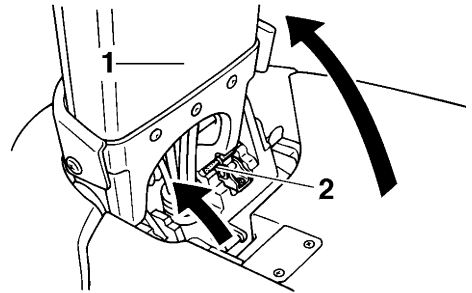

- 1 Steering pole  
2 Lock pin

- (2) Grasp the tab, pull the band to the rear, and then pull it up.

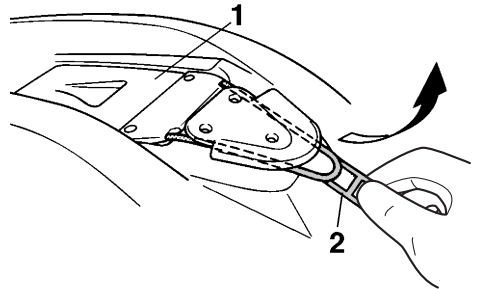

- 1 Fire extinguisher container  
2 Tab

- (3) Lift the fire extinguisher container about 30 degrees from the storage position. **NOTICE: Do not force the fire extinguisher container up more than 30 degrees from the storage position, otherwise the container and hood could be damaged.** [ECJ00402]

# Equipment operation

---

- (4) Loosen the fire extinguisher container cap and remove it.

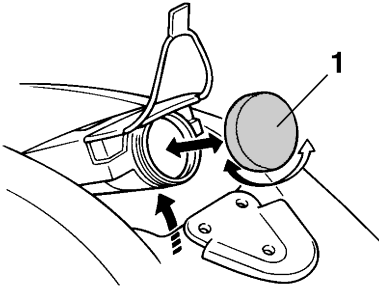

1 Fire extinguisher container cap

## To close the fire extinguisher container:

- (1) Insert the fire extinguisher into the container, and then securely install the fire extinguisher container cap by tightening it until it stops.
- (2) Lower the container on the hood to its storage position and secure it with the band.
- (3) While holding the steering pole, move the lock pin to the stowed position, and then lower the steering pole.



# Operation and handling requirements

EJU31793

## Fuel and engine oil requirements

EJU44841

### Fuel

EWJ00283

#### **WARNING**

- Gasoline and gasoline vapors are extremely flammable. To avoid fires and explosions and to reduce the risk of injury when refueling, follow these instructions.
- Gasoline is poisonous and can cause injury or death. Handle gasoline with care. Never siphon gasoline by mouth. If you should swallow some gasoline, inhale a lot of gasoline vapor, or get some gasoline in your eyes, see your doctor immediately. If gasoline spills on your skin, wash with soap and water. If gasoline spills on your clothing, change your clothes.

ECJ00322

#### **NOTICE**

- Do not use leaded gasoline. Leaded gasoline can seriously damage the engine.
- Avoid getting water and contaminants in the fuel tank. Contaminated fuel can cause poor performance and engine damage. Use only fresh gasoline that has been stored in clean containers.

#### Recommended fuel:

Regular unleaded gasoline with a minimum octane rating of  
86  
(Pump octane number) = (R + M)/2  
90 (Research octane number)



#### TIP:

- This mark identifies the recommended fuel for this watercraft as specified by European regulation (EN228).
- Check that gasoline nozzle has the same identifier when fueling.

#### Gasohol

There are two types of gasohol: gasohol containing ethanol and that containing methanol. Gasohol containing ethanol can be used if ethanol content does not exceed 10% and the fuel meets the minimum octane ratings. E-85 is a fuel blend containing 85% ethanol and therefore must not be used in this watercraft. All ethanol blends containing more than 10% ethanol can cause fuel system damage or engine performance problems.

Yamaha does not recommend gasohol containing methanol because it can cause fuel system damage and engine performance problems.

# Operation and handling requirements

EJU31873

## 2-stroke engine oil

Recommended engine oil:  
YAMALUBE 2-W or TC-W3 outboard motor oil or equivalent

If YAMALUBE 2-W engine oil is not available, another 2-stroke engine oil with an NMMA-certified TC-W3 rating may be used.

EJU31903

## Mixing fuel and oil

ECJ00332

### NOTICE

**Make sure that the gasoline and oil are thoroughly mixed in the correct ratio, otherwise severe engine damage could result.**

To mix gasoline and engine oil:

- (1) Pour 2-stroke engine oil into a clean container, and then add gasoline.

Fuel-to-oil ratios (gasoline to oil)  
Break-in period (first two tankfuls):  
25:1  
After break-in:  
50 : 1

- (2) To mix them thoroughly, shake the container from side to side.

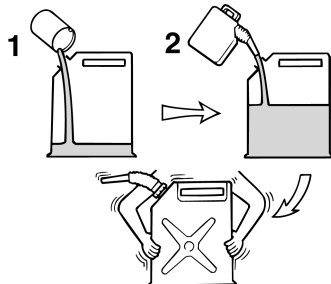

- 1 2-stroke engine oil
- 2 Gasoline

EJU31917

## Filling the fuel tank

To fill the fuel tank:

- (1) Before refueling, stop the engine. Do not stand or sit on the watercraft. Never refuel while smoking, or while in the vicinity of sparks, open flames, or other sources of ignition.
- (2) Place the watercraft in a well-ventilated area and in a horizontal position.
- (3) Remove the hood, and then check the fuel level. (See page 23 for hood removal and installation procedures.)
- (4) Loosen the fuel filler cap and remove it.

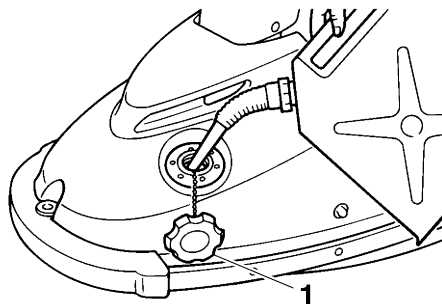

1 Fuel filler cap

- (5) Slowly add fuel to the fuel tank.

Fuel tank capacity:

Total:  
18 L (4.8 US gal, 4.0 Imp.gal)  
Reserve:  
5.5 L (1.5 US gal, 1.2 Imp.gal)

- (6) Stop filling when the fuel level just reaches the bottom of the filler tube. Do not fill up the filler tube. Because fuel expands when it heats up, heat from the engine or the sun can cause fuel to spill out of the fuel tank. Do not leave the watercraft with a full tank in direct sunlight.
- (7) Wipe up any spilled fuel immediately with a dry cloth.

# Operation and handling requirements

---

- (8) Securely install the fuel filler cap by tightening it until it stops.
- (9) Securely install the hood in its original position.

EJU40022

## Draining the bilge water

ECJ01302

### **NOTICE**

---

**Do not run the engine at full throttle when bilge water remains in the engine compartment. The bilge water can splash into the engine, which can result in severe damage.**

---

EJU40922

## Draining the bilge water on water

A small quantity of bilge water will remain in the engine compartment even after the bilge water is drained on water. To completely remove the bilge water, remove the watercraft from the water and wipe up any remaining moisture in the engine compartment with a dry cloth.

### **Jet vacuum bilge draining system**

While the watercraft is operating, bilge water in the engine compartment is drawn in by the vacuum that is generated in the jet pump and discharged from the watercraft through the jet thrust nozzle.

To drain the bilge water on water:

Operate the watercraft as straight as possible and above planing speed for at least 2 minutes. **NOTICE: Do not run the engine at full throttle for at least 1 minute after the engine has been restarted. Bilge water in the engine compartment can splash into the**

# Operation and handling requirements

---

engine, which can result in severe damage. [EGJ00554]

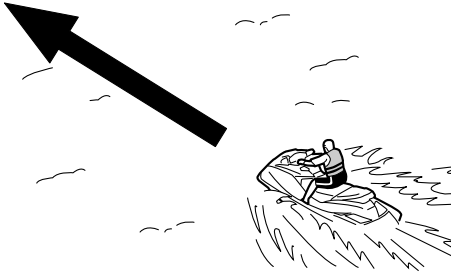

EJU33424

## Transporting

EWJ00751

### **WARNING**

Always turn the fuel cock knob to “OFF” when transporting the watercraft, otherwise fuel could leak out into the engine or engine compartment, which would create a fire hazard.

---

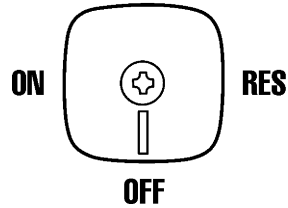

When transporting the watercraft on a trailer, secure the bow rope hole and stern of the watercraft to the trailer with ropes or tie downs. Use a rubber shock cord to secure the steering pole to the watercraft. **NOTICE:** Do not secure the steering pole with ropes or tie downs and do not secure it to the trailer. Also, do not transport the watercraft with the steering pole up. Otherwise, the steering pole could be damaged. Wrap the ropes or tie downs with towels or rags

# Operation and handling requirements

---

where they touch the body of the watercraft to avoid scratches or damage. [EGJ00633]

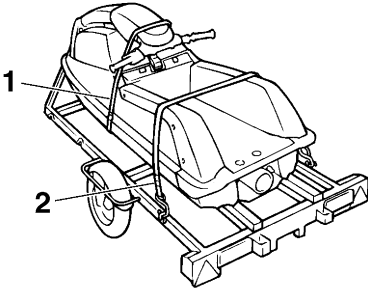

- 1 Rubber shock cord
- 2 Tie down

# First-time operation

---

EJU32757

## Engine break-in

ECJ00432

### **NOTICE**

---

**Failure to perform the engine break-in could result in reduced engine life or even severe engine damage.**

---

The engine break-in is essential to allow the various components of the engine to wear and polish themselves to the correct operating clearances. This ensures proper performance and promotes longer component life.

To perform the engine break-in:

- (1) Fill the fuel tank with fuel in a fuel-to-oil ratio of 25:1. (See page 28 “Mixing fuel and oil” and “Filling the fuel tank” for information on filling the fuel tank.)
- (2) Launch the watercraft and start the engine. (See page 41 for information on starting the engine.)
- (3) For the first 5 minutes, operate with the engine at idling speed.
- (4) For the first tankful of fuel, squeeze the throttle lever slowly and operate at 3/4 throttle or less.
- (5) Fill the fuel tank once more with fuel in a fuel-to-oil ratio of 25:1, and then operate with the engine at any speed.

After the engine break-in is complete, fill the fuel tank with fuel in a fuel-to-oil ratio of 50:1.

The watercraft can be operated normally.

# Pre-operation checks

EJU31982

EWJ00412



**Failure to inspect or maintain the watercraft properly increases the possibility of an accident or damage to the watercraft. Do not operate the watercraft if you find any problem. If a problem cannot be corrected by the procedures provided in this manual, have the watercraft inspected by a Yamaha dealer.**

EJU41234

## Pre-operation checklist

Before using this watercraft, be sure to perform the checks in the following checklist.

ITEM	ROUTINE	PAGE
<b>PRE-LAUNCH CHECKS</b>		
<b>Engine compartment</b>	Ventilate the engine compartment. Check inside the engine compartment for damage.	35
<b>Fuel system</b>	Check the fuel system for leakage. Check the fuel level in the fuel tank.	35
<b>Water separator</b>	Check the water separator for water.	36
<b>Engine unit</b>	Check the exterior of the engine unit for damage.	36
<b>Bilge water</b>	Check the engine compartment for bilge water.	36
<b>Battery</b>	Check the battery connections and electrolyte level.	36
<b>Steering system</b>	Check the steering system for proper operation.	36
<b>Throttle lever</b>	Check the throttle lever for proper operation. Check the throttle lever free play.	37
<b>Engine shut-off cord (lanyard)</b>	Check the engine shut-off cord (lanyard) for damage.	38
<b>Switches</b>	Check the start switch, engine stop switch, and engine shut-off switch for proper operation.	38
<b>Storage pouch</b>	Check the storage pouch for damage and water. Check that the storage pouch is securely installed.	38
<b>Fire extinguisher container</b>	Check the fire extinguisher container for damage.	39
<b>Fire extinguisher</b>	Check the condition of the fire extinguisher.	39
<b>Safety equipment</b>	Check that safety equipment meeting the applicable regulations is on board.	39
<b>Hull and deck</b>	Check the hull and deck for damage.	39
<b>Jet intake</b>	Check the jet intake for damage and clogging.	39
<b>Hood</b>	Check that the hood is securely closed.	39

# Pre-operation checks

---

ITEM	ROUTINE	PAGE
<b>POST-LAUNCH CHECKS</b>		
<b>Cooling water pilot outlet</b>	Check that water is discharged from the cooling water pilot outlet while the engine is running.	39

**TIP:**

To ensure safety and reliability, pre-operation checks should be made each time the watercraft is used.



# Pre-operation checks

EJU32282

## Pre-operation check points

EJU40686

### Pre-launch checks

Perform the pre-launch checks in the pre-operation checklist while the watercraft is on land.

To perform the pre-launch checks:

- (1) Remove the hood. (See page 23 for hood removal and installation procedures.)
- (2) Perform the checks and make sure that there are no malfunctioning items or other problems.
- (3) After completing these checks, install the hood in its original position.

EJU32334

### Engine compartment check

EWJ00462



**Failure to ventilate the engine compartment could result in a fire or explosion. Do not start the engine if there is a fuel leak.**

Ventilate the engine compartment. Leave the engine compartment open for a few minutes to allow any fuel vapors to escape.

Make sure that there is no damage inside the engine compartment.

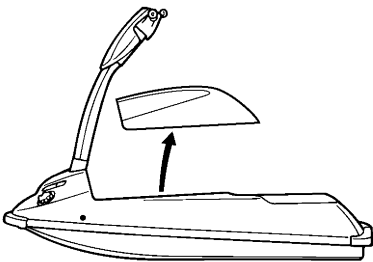

EJU34208

### Fuel system checks

EWJ00382



**Leaking fuel can result in fire or explosion.**

- Check for fuel leakage regularly.

- If any fuel leakage is found, the fuel system must be repaired by a qualified mechanic. Improper repairs can make the watercraft unsafe to operate.

Make sure that there is no damage, leakage, or other problem in the fuel system.

### Check:

- Carburetor for leakage
- Fuel filler cap and seal for damage
- Fuel in fuel tank for water and dirt
- Fuel tank for damage and leakage
- Fuel hoses and joints for damage and leakage
- Fuel filter for leakage
- Fuel cock for leakage
- Fuel tank breather hose for damage and leakage

### Releasing the pressure in the fuel tank

Release the pressure in the fuel tank before each use.

To release the pressure in the fuel tank:

- (1) Loosen the fuel filler cap slowly and remove it to release any pressure in the fuel tank.

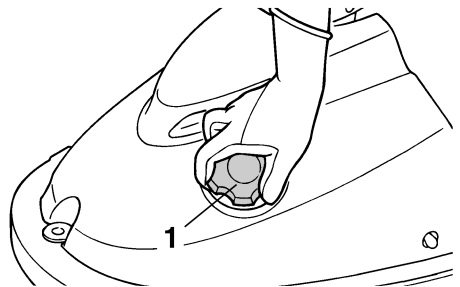

1 Fuel filler cap

- (2) Securely install the fuel filler cap by tightening it until it stops.

EJU32365

### Fuel level check

Check the fuel level in the fuel tank.

# Pre-operation checks

Add fuel if necessary. (See page 28 for information on filling the fuel tank.)

EJU32424

## Water separator check

Make sure that no water has collected in the water separator. If water has collected in the water separator, drain it. (See page 22 for information on draining the water separator.)

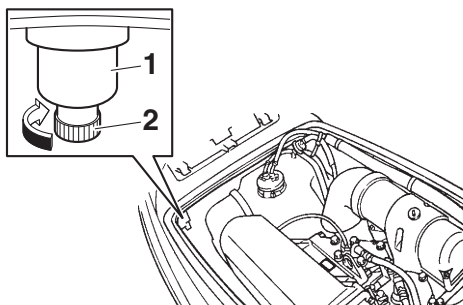

- 1 Water separator
- 2 Drain screw

EJU40182

## Engine unit check

Check the exterior of the engine unit for damage or other problem.

EJU41012

## Bilge water check

Make sure that no bilge water has collected in the engine compartment. If bilge water has collected in the engine compartment, wipe it up with a dry cloth. **NOTICE: Excessive water in the engine compartment can splash into the engine, which can result in severe damage.** [ECJ00342]

EJU32485

## Battery checks

Make sure that the battery terminals and breather hose are not damaged and that the battery leads and breather hose are connected properly. **WARNING! Fire or explosion could result if the breather hose is dam-**

**aged, obstructed, or not connected properly.** [EWJ00452]

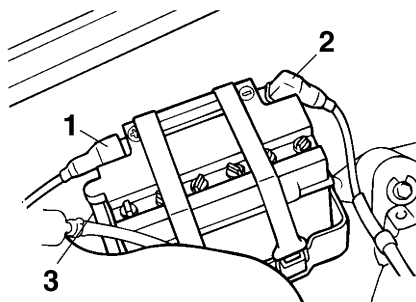

- 1 Positive (+) battery terminal: Red lead
- 2 Negative (-) battery terminal: Black lead
- 3 Breather hose

Make sure that the electrolyte level is between the minimum and maximum level marks. **WARNING! Never operate the watercraft if the battery does not have sufficient power to start the engine or if it shows any other signs of decreased power. Loss of battery power may leave you stranded.** [EWJ01241]

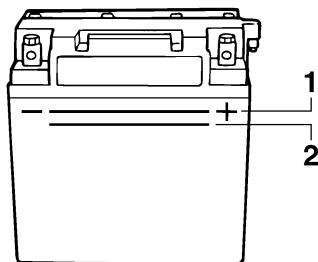

- 1 Maximum level mark
- 2 Minimum level mark

Make sure that the battery is securely held in place.

EJU32614

## Steering system checks

Turn the handlebars to the right and left several times to make sure that operation is smooth and unrestricted throughout the

# Pre-operation checks

whole range, and that the free play is not excessive.

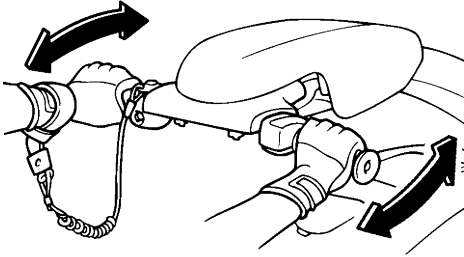

Turn the handlebars as far as possible to the right and left to make sure that the jet thrust nozzle moves as the handlebars are turned, and that there is no difference between the right and left fully turned positions of the jet thrust nozzle.

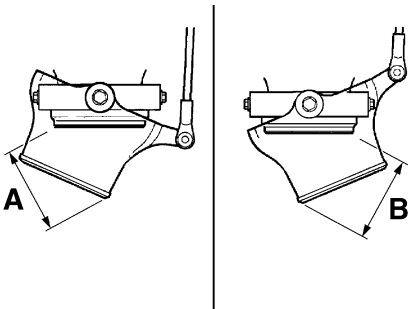
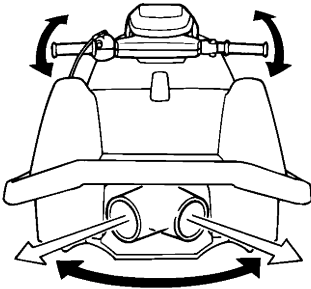

Difference between fully turned positions of jet thrust nozzle (distances A and B):

Maximum 5 mm (0.20 in)

EJU32623

## Steering pole check

Move the steering pole up and down several times to make sure that operation is smooth and unrestricted throughout the whole range, and that the free play is not excessive. Also, make sure that the steering pole does not have any side play.

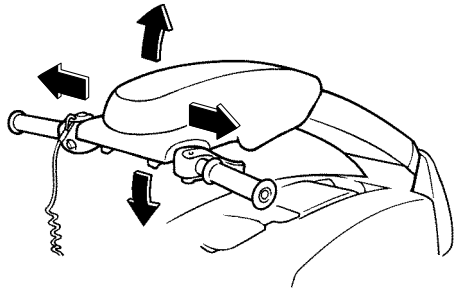

EJU32595

## Throttle lever checks

Operate the throttle lever several times to make sure that operation is smooth throughout the whole range. Also, make sure that the throttle lever returns automatically to its fully closed (idle) position when released.

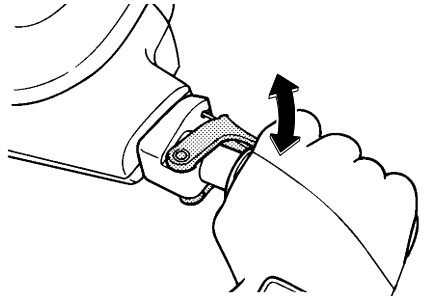

# Pre-operation checks

Make sure that there is the proper amount of throttle lever free play when the throttle lever is in the fully closed (idle) position.

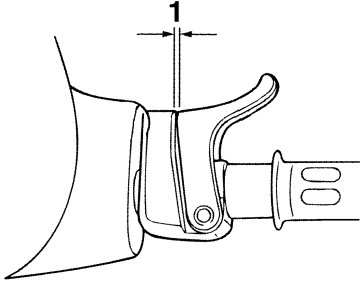

1 Throttle lever free play

Throttle lever free play:  
7.0–10.0 mm (0.28–0.39 in)

EJU32664

## Engine shut-off cord (lanyard) check

Make sure that the engine shut-off cord (lanyard) is not damaged. If the cord is damaged, replace it. **WARNING! Never try to repair the engine shut-off cord (lanyard) or tie it together. The engine shut-off cord (lanyard) may not pull free when the operator falls off, allowing the watercraft to continue to run and cause an accident.** [EWJ01221]

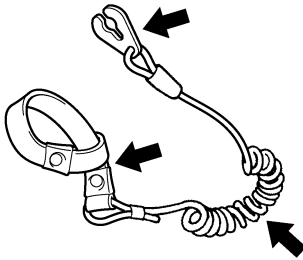

EJU41021

## Switch checks

ECJ01361

### NOTICE

**Do not run the engine for more than 15 seconds on land without supplying water, otherwise the engine could overheat.**

Check the start switch, the engine stop switch, and the engine shut-off switch for proper operation. (See pages 19 to 19 for information on operating each switch.)

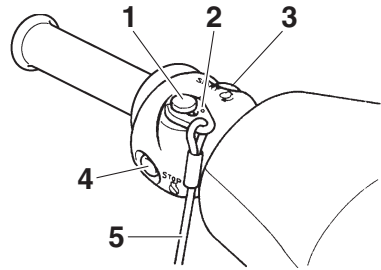

- 1 Engine shut-off switch
- 2 Clip
- 3 Start switch
- 4 Engine stop switch
- 5 Engine shut-off cord (lanyard)

### To check the operation of the switches:

- (1) Push the start switch to make sure that the engine starts.
- (2) As soon as the engine starts running, push the engine stop switch to make sure that the engine stops immediately.
- (3) Restart the engine, and then pull the engine shut-off cord (lanyard) to remove the clip from the engine shut-off switch to make sure that the engine stops immediately.

EJU41211

## Storage pouch checks

Make sure that the storage pouch is not damaged and that water has not collected in the pouch. Also, make sure that the storage

# Pre-operation checks

pouch is securely installed. (See page 24 for information on the storage pouch.)

EJU41072

## Fire extinguisher container checks

Make sure that the fire extinguisher container is not damaged and is securely held in place. (See page 25 for information on the fire extinguisher container.)

EJU32504

## Fire extinguisher check

Check that there is a full fire extinguisher on board.

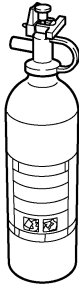

To check the fire extinguisher, see the instructions supplied by the fire extinguisher manufacturer. Always keep the fire extinguisher in the fire extinguisher container.

Always carry a fire extinguisher on board. A fire extinguisher is not standard equipment with this watercraft. If you do not have one, contact a Yamaha dealer or a fire extinguisher dealer to obtain one meeting the proper specifications.

EJU40122

## Safety equipment check

Check that safety equipment meeting the applicable regulations is on board.

EJU32353

## Hull and deck check

Check the hull and deck for damage or other problem.

EJU32657

## Jet intake checks

Make sure that the jet intake is not damaged or clogged with weeds or debris. If the in-

take is clogged, clean it. (See page 66 for information on the jet intake.)

EJU40703

## Hood check

Make sure that the hood is securely closed. (See page 23 for information on the hood.)

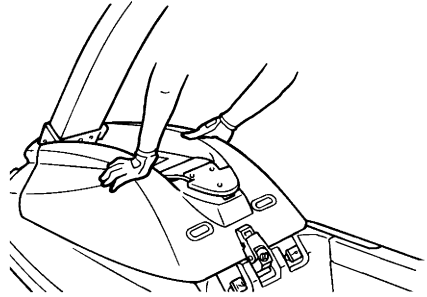

EJU40146

## Post-launch checks

Perform the post-launch checks in the pre-operation checklist while the watercraft is in the water and the engine is running.

To perform the post-launch checks:

- (1) Launch the watercraft. (See page 41 for information on launching the watercraft.)
- (2) Perform the checks and make sure that there are no malfunctioning items or other problems.

EJU40553

## Cooling water pilot outlet check

Make sure that water is discharged from the cooling water pilot outlet while the engine is running. (See page 21 for information on the cooling water pilot outlet.)

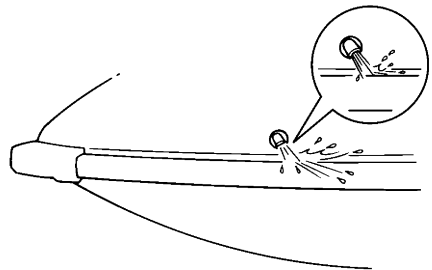

# Operation

EJU32903

## Operating your watercraft

EWJ00511



**Before operating your watercraft, become familiar with all of the controls. Consult a Yamaha dealer about any control or function that you do not fully understand. Failure to understand how the controls work could cause an accident or prevent you from avoiding an accident.**

EJU32924

## Getting to know your watercraft

Operating your watercraft requires skills acquired through practice over a period of time. Take the time to learn the basic techniques well before attempting more difficult maneuvers.

Operating your new watercraft can be a very enjoyable activity, providing you with hours of pleasure. However, it is essential to familiarize yourself with the operation of the watercraft to achieve the skill level necessary to enjoy riding safely.

Before operating this watercraft, read this owner's/operator's manual, the Riding Practice Guide, the Riding Instruction card, and all labels on the watercraft. Pay particular attention to the safety information beginning on page 8. These materials should give you an understanding of the watercraft and its operation.

Remember: This watercraft is designed to carry the operator only. Never have more than one person on the watercraft at any time.

EJU32985

## Learning to operate your watercraft

Before operating the watercraft, always perform the pre-operation checks listed on page 33. The short time spent checking the water-

craft will reward you with added safety and reliability.

Check local laws before operating your watercraft.

Operate defensively at safe speeds and keep a safe distance away from people, objects, and other watercraft. Select a wide area to practice maneuvering in, where there is good visibility and light boat traffic.

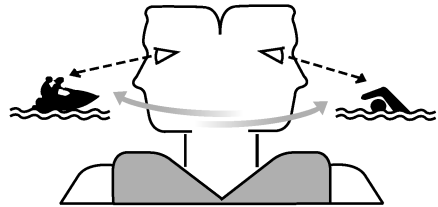

Use the buddy system—operate with someone nearby. Scan constantly for people, objects, and other watercraft. Be alert for conditions that limit your visibility or block your vision of others.

You should grip the handlebars firmly and get to a standing or kneeling position quickly. Keep both feet or knees on the riding tray when the watercraft is in motion.

EJU33172

## Operating positions

After you are underway, you may choose to kneel or stand, depending upon watercraft speed, your skill level, and your preference. Here are some guidelines.

### Kneeling

It is easier to maintain your balance when kneeling than when standing. This position is recommended when traveling at sub-planing speeds. (At sub-planing speeds, there is a

wake, but the watercraft is moving through the water rather than skimming on top of it.)

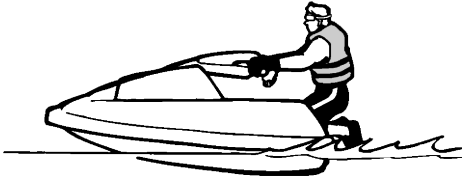

At very slow speeds, it may be necessary to support your upper-body weight with your elbows resting on the gunwales, trailing your legs in the water.

### Standing

After you are comfortable handling the watercraft from a kneeling position, try standing as the watercraft gains speed. The watercraft will become easier to balance as the speed increases, because jet thrust provides stability as well as directional control. When you are moving slowly, or preparing to stop, you will probably need to return to the kneeling position to maintain your balance.



EJU32822

### Launching the watercraft

When launching the watercraft, make sure that there are no obstacles around you.

If the watercraft is launched from a trailer, someone should make sure that waves do not push the watercraft into the trailer.

After the watercraft is in the water, turn it around so that the bow faces the direction you wish to go.

EJU32836

### Starting the engine on water

EWJ01521



### WARNING

**Do not apply throttle when others are at the rear of the watercraft. Turn the engine off or keep it at idle. Water and debris exiting the jet thrust nozzle can cause severe injury.**

### To start the engine:

- (1) Move the watercraft to an area that is free from weeds and debris, and has a water depth of at least 60 cm (2 ft) from the bottom of the watercraft. **NOTICE:** **Never run the engine in water that is less than 60 cm (2 ft) deep from the bottom of the watercraft, otherwise pebbles or sand could be sucked into the jet intake, causing impeller damage and engine overheating.** [ECJ00473]

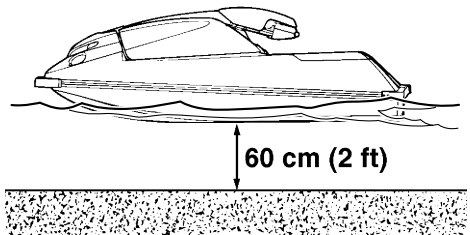

# Operation

- (2) Turn the fuel cock knob to “ON”.

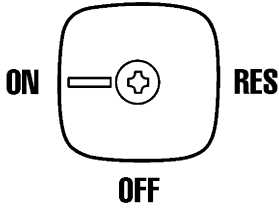

- (3) Attach the engine shut-off cord (lanyard) to your left wrist, and then attach the clip to the engine shut-off switch. (See page 19 for information on operating the engine shut-off switch.) **WARNING! Check that the engine shut-off cord (lanyard) is attached correctly. If the engine shut-off cord (lanyard) is not attached correctly, it may not pull free when the operator falls off, allowing the watercraft to continue to run and cause an accident.** [EWJ00582]

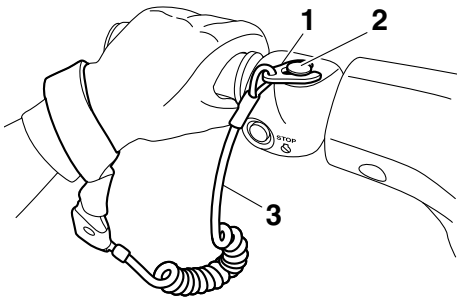

- 1 Clip  
2 Engine shut-off switch  
3 Engine shut-off cord (lanyard)

- (4) Pull the choke knob all the way out to start a cold engine.

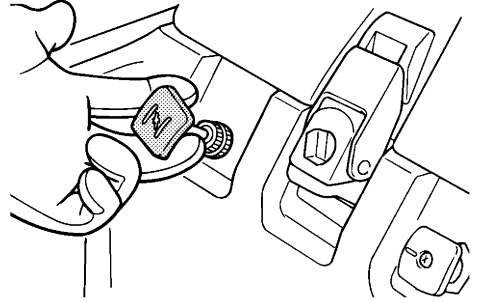

### TIP:

The choke should not be used when the engine is warm.

- (5) While lightly squeezing the throttle lever, push the start switch (green button) to start the engine. (See page 19 for information on operating the start switch.) **WARNING! Do not apply too much throttle when starting the engine, otherwise the watercraft will accelerate unexpectedly. This could cause a collision or cause the operator to be thrown overboard.** [EWJ00592]

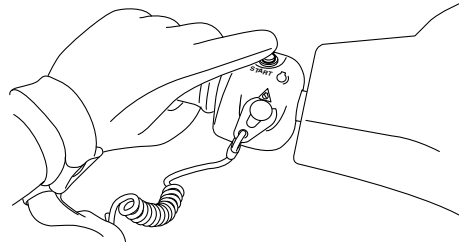

- (6) After the engine has warmed up, push the choke knob in to its original position.

### TIP:

If the choke knob is left pulled out, the engine will stall.



EJU32863

## Stopping the engine

Release the throttle lever, and then push the engine stop switch (red button) to stop the engine. **WARNING! You need throttle to steer. Shutting the engine off can cause you to hit an obstacle you are attempting to avoid. A collision could result in severe injury or death.** [EWJ00602]

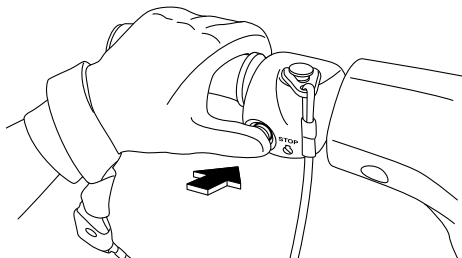

EJU32873

## Leaving the watercraft

If leaving the watercraft, remove the clip from the engine shut-off switch to prevent accidental starting or unauthorized operation by children or others.

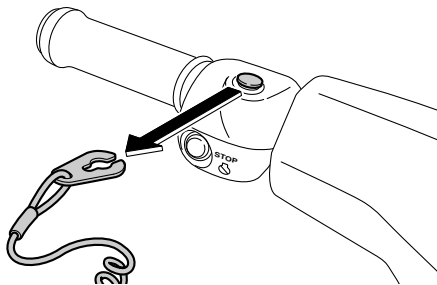

EJU41172

## Operating the watercraft

When the engine is running, the watercraft will move forward at trolling speed even if the

throttle lever is in the fully closed (idle) position.

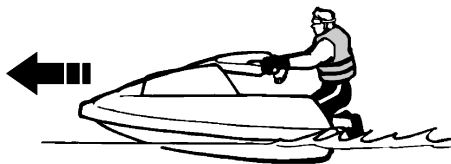

EJU33244

## Turning the watercraft

EWJ00762

### **WARNING**

- Do not release the throttle lever when trying to steer away from objects—you need throttle to steer. A collision could result in severe injury or death.
- When operating at higher speeds, make gradual turns or slow down before turning. Sharp high-speed turns may cause the watercraft to slide sideways or spin, throwing the operator overboard, which could cause an injury.

Steering control depends on the combination of handlebar position and the amount of throttle.

Water sucked in through the intake grate is pressurized by the impeller in the jet pump. As the pressurized water is expelled from the pump through the jet thrust nozzle, it creates thrust to move and steer the watercraft. The higher the engine speed, the more thrust produced.

The amount of jet thrust, in addition to the position of the handlebars, determines how sharply you turn.

# Operation

---

A. More throttle produces higher thrust, so the watercraft will turn more sharply.

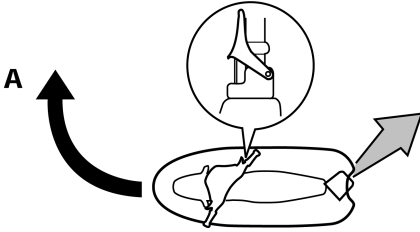

alone using just the amount of thrust available at idle.

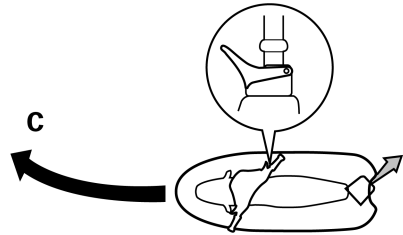

B. Less throttle produces lower thrust, so the watercraft will turn more gradually.

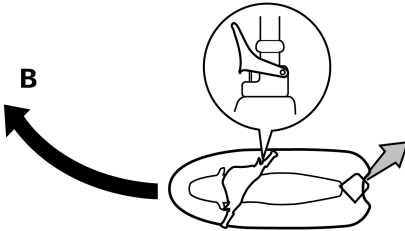

D. If the engine is stopped while riding, there is no thrust. The watercraft will go straight even though the handlebars are turned.

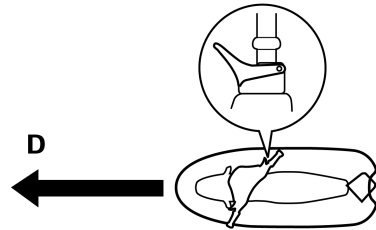

C. Releasing the throttle lever completely produces only minimum thrust. If you are traveling at speeds above trolling, you will have rapidly decreasing ability to steer without throttle. You may still have some turning ability immediately after releasing the throttle lever, but once the engine slows down, the watercraft will no longer respond to handlebar input until you apply throttle again or you reach trolling speed.

At trolling speed, the watercraft can be turned gradually by handlebar position

## **You need throttle to steer.**

To maintain your balance, lean into a turn. How much you lean depends on the sharpness of the turn and your traveling speed. In

general, the higher the speed or the sharper the turn, the more you lean.

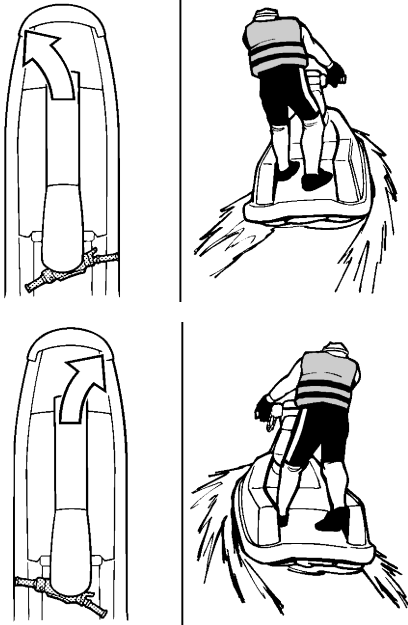

hitting an obstacle, apply throttle and turn in another direction.

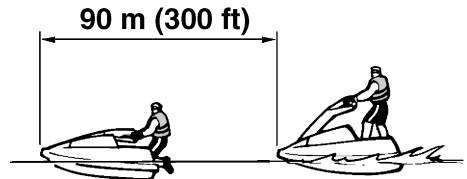

EWJ00723

## **WARNING**

- Allow adequate stopping distance.
- Take early action to avoid collisions. Remember, watercraft and other boats do not have brakes.
- Operate defensively at safe speeds and keep a safe distance away from people, objects, and other watercraft to give you time to stop.
- Do not shut the engine off when slowing down in case you need engine power to steer away from a boat or other obstacle that comes into your path.

EJU33273

## Stopping the watercraft

The watercraft is not equipped with a separate braking system. It is stopped by water resistance when the throttle lever is released. From full speed, the watercraft comes to a complete stop in approximately 90 m (300 ft) after the throttle lever is released or the engine is stopped, although this distance will vary depending on many factors, including gross weight, water surface conditions, and wind direction. The watercraft slows down as soon as the throttle lever is released, but will coast for a distance before fully stopping. If you are not sure you can stop in time before

EJU33075

## Starting off

EWJ00712

## **WARNING**

To avoid collisions:

- Scan constantly for people, objects, and other watercraft. Be alert for conditions that limit your visibility or block your vision of others.
- Operate defensively at safe speeds and keep a safe distance away from people, objects, and other watercraft.
- Do not follow directly behind watercraft or other boats. Do not go near others to spray or splash them with water. Avoid

# Operation

sharp turns or other maneuvers that make it hard for others to avoid you or understand where you are going. Avoid areas with submerged objects or shallow water.

- Take early action to avoid collisions. Remember, watercraft and other boats do not have brakes. Do not release the throttle lever when trying to steer away from objects—you need throttle to steer.

EWJ00633

## WARNING

Avoid forceful jet thrust and limited visibility while reboarding. Get to a standing or kneeling position quickly, but do not expose yourself to the forceful jet thrust.

ECJ01341

## NOTICE

Never run the engine in water that is less than 60 cm (2 ft) deep from the bottom of the watercraft, otherwise pebbles or sand could be sucked into the jet intake, causing impeller damage and engine overheating.

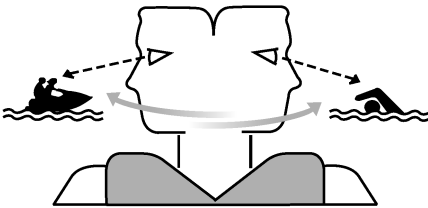

The watercraft is less stable when at a standstill or at a slow speed. It takes skill to keep the watercraft upright when starting.

To stabilize the watercraft when accelerating to planing speed, maintain a low center of

gravity by operating it in the kneeling position.

Even though it is easier to start in shallow water, you must learn deep-water boarding first. You will inevitably fall off, so be sure you know how to get back on the watercraft once you are away from shore.

EJU33105

## Boarding and starting in shallow water

Be sure to learn the deep-water starting method before operating the watercraft in water where it is too deep for you to stand. (See page 47 for the deep-water starting method.)

- (1) Launch the watercraft in water free from weeds and debris and at least 60 cm (2 ft) deep from the bottom of the watercraft. **NOTICE: Never run the engine in water that is less than 60 cm (2 ft) deep from the bottom of the watercraft, otherwise pebbles or sand could be sucked into the jet intake, causing impeller damage and engine overheating.** [ECJ00473]
- (2) Attach the engine shut-off cord (lanyard) to your left wrist, and then attach the clip to the engine shut-off switch.
- (3) Grip the handlebars with both hands. Place one knee on the riding tray and balance there.



- (4) Look in all directions, start the engine, and then begin to accelerate.

- (5) Pull your other knee up onto the riding tray as the watercraft speed increases.



left wrist, and then attach the clip to the engine shut-off switch.

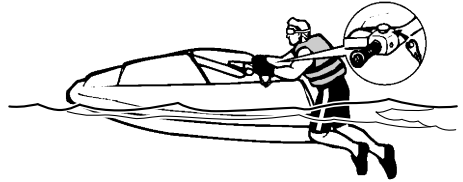

- (6) Move as far forward as possible without interfering with the movement of the handlebars. Keep your body perpendicular to the water, with your weight forward and low.

## TIP:

The watercraft will become easier to balance as the speed increases, because jet thrust provides stability as well as directional control.

EJU33125

## Boarding and starting in deep water

EWJ01261



## WARNING

**Be sure the operator have practiced boarding from the water while still close to shore before riding. A person who has made many unsuccessful attempts to get back on the watercraft may become fatigued and suffer from exposure, increasing the risk of injury and drowning.**

- (2) Grip the handlebars with both hands. Pull your body up onto the riding tray and balance there, using your elbows on the gunwales for leverage.



- (1) Swim to the rear of the watercraft. Attach the engine shut-off cord (lanyard) to your

- (3) Look in all directions, start the engine, and then begin to accelerate.
- (4) Continue to pull your body up onto the watercraft as the watercraft speed increases.

# Operation

- (5) Bring your knees up onto the riding tray and change to a kneeling position as soon as you can do so.



- (6) Move as far forward as possible without interfering with the movement of the handlebars. Keep your body perpendicular to the water, with your weight forward and low.
- (7) Once the bow drops, and the watercraft has leveled out in the water and reached planing speed, back off the throttle and select your desired speed.

## TIP:

- The watercraft will become easier to balance as the speed increases, because jet thrust provides stability as well as directional control.
- It will take longer for a heavy operator to reach planing speed than it will for a light operator.

EJU33205

## Capsized watercraft

EWJ00672



**WARNING**

Improper uprighting can cause injury.

- Be sure to shut the engine off by pulling on the engine shut-off cord (lanyard) to remove the clip from the engine shut-off switch.
- Do not put your hands in the intake grate.

If the watercraft capsizes, turn it over immediately.

To upright the watercraft:

- (1) Remove the clip from the engine shut-off switch.
- (2) Swim to the rear of the watercraft. Turn the watercraft over clockwise.

If the port (left) side of the capsized watercraft is tilting up, push down on the gunwale so that the port (left) side is down before turning the watercraft clockwise. **NOTICE: Do not turn the watercraft over counterclockwise, otherwise water can enter the engine, which can result in severe damage.**

[ECJ00542]

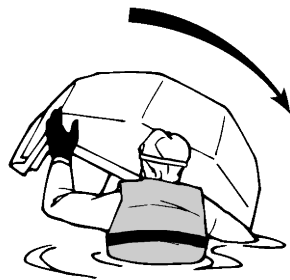
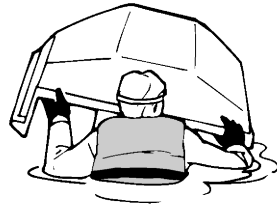

- (3) Start the engine and operate the watercraft at planing speed to drain the bilge water in the engine compartment. (See page 29 for information on draining the bilge water. If the engine does not start,

see “Towing the watercraft” on page 68 or “Submerged watercraft” on page 69.)

**NOTICE: Do not run the engine at full throttle for at least 1 minute after the engine has been restarted. Bilge water in the engine compartment can splash into the engine, which can result in severe damage.** [ECJ00554]

EJU33303

## Beaching the watercraft

To beach the watercraft:

- (1) Make sure that there are no boats, swimmers, or obstacles near the beach.
- (2) Release the throttle lever to reduce speed about 90 m (300 ft) before you reach the intended beaching area.
- (3) Slowly approach the beach and stop the engine just before reaching land.  
**WARNING! You need throttle to steer. Shutting the engine off can cause you to hit an obstacle you are attempting to avoid. A collision could result in severe injury or death.** [EJVJ00602] **NOTICE: Never run the engine in water that is less than 60 cm (2 ft) deep from the bottom of the watercraft, otherwise pebbles or sand could be sucked into the jet intake, causing impeller damage and engine overheating.** [ECJ00473]
- (4) Get off the watercraft and pull it up on the beach.

EJU37194

## Operating in weeded areas

Always avoid using your watercraft in areas where weed growth is thick. If operating in weeded areas is unavoidable, alternately squeeze the throttle lever and relax your grip on the throttle lever to vary the engine speed. Weeds tend to become clogged more when operating at a steady speed and at trolling speed. If weeds may have clogged the intake

area, clean the jet intake. (See page 66 for information on the jet intake.)

EJU41061

## After removing the watercraft from the water

ECJ01361

### **NOTICE**

**Do not run the engine for more than 15 seconds on land without supplying water, otherwise the engine could overheat.**

After operating and removing the watercraft from the water, promptly discharge the remaining water from the cooling water passages.

To discharge water from the cooling water passages:

- (1) Make sure that the area around the watercraft is clear, and then start the engine.
- (2) Discharge the remaining water out of the cooling water passages by alternately squeezing and releasing the throttle lever quickly for 10 to 15 seconds.
- (3) Stop the engine.

# Care and storage

EJU41192

## Post-operation care

EWJ00321

### **WARNING**

Always turn the fuel cock knob to “OFF” when storing the watercraft, otherwise fuel could leak out into the engine or engine compartment, which would create a fire hazard.

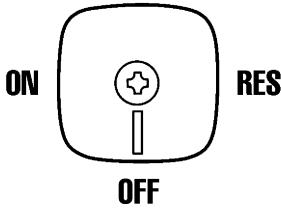

After using the watercraft, always take it out of the water, clean it, and store it. Leaving the watercraft in the water for extended periods will accelerate the rate of normal deterioration of the jet pump and hull. Marine organisms and corrosion are some of the conditions that can shorten the life of many watercraft components.

EJU3351A

## Flushing the cooling water passages

ECJ01361

### **NOTICE**

Do not run the engine for more than 15 seconds on land without supplying water, otherwise the engine could overheat.

Flush the cooling water passages to prevent them from clogging with salt, sand, or dirt.

- (1) Place the watercraft in a horizontal position.
- (2) Remove the hood. (See page 23 for hood removal and installation procedures.)

- (3) Connect the garden hose adapter to a garden hose.

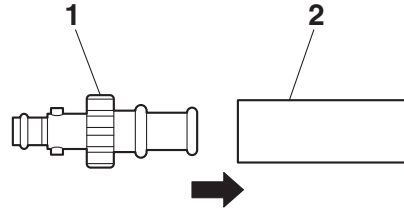

- 1 Garden hose adapter
- 2 Garden hose

- (4) Loosen the flushing hose connector cap and remove it. Insert the garden hose adapter into the flushing hose connector by pushing and twisting it until it is securely connected.

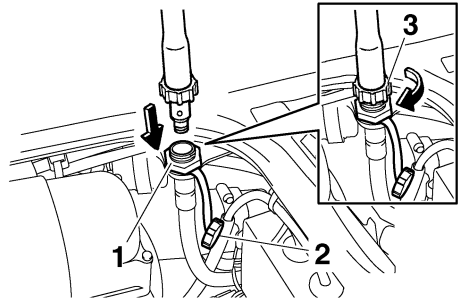

- 1 Flushing hose connector
- 2 Flushing hose connector cap
- 3 Garden hose adapter

- (5) Connect the garden hose to a water tap.
- (6) Make sure that the area around the watercraft is clear, and then start the engine. Immediately after the engine starts, turn the water supply on gradually until



water flows out continually from the cooling water pilot outlet.

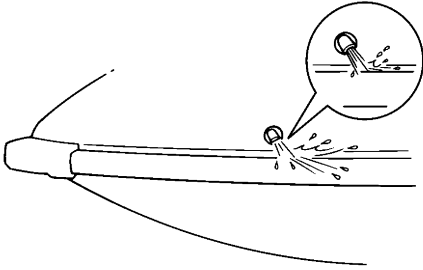

- (7) Run the engine at idling speed for about 3 minutes watching the engine condition. If the engine stops while flushing, turn the water supply off immediately and perform the procedure again from step 6.  
**NOTICE: Do not supply water to the cooling water passages when the engine is not running. The water could flow back through the muffler into the engine, causing severe engine damage.** [ECJ00123]
- (8) Turn the water supply off.
- (9) Discharge the remaining water out of the cooling water passages by alternately squeezing and releasing the throttle lever quickly for 10 to 15 seconds.
- (10) Stop the engine.
- (11) Remove the garden hose adapter, and then securely install the flushing hose connector cap by tightening it until it stops.
- (12) Securely install the hood in its original position.

EJU40743

## Cleaning the watercraft

- (1) Remove the hood. (See page 23 for hood removal and installation procedures.)
- (2) Rinse the engine and engine compartment with a small amount of water.

**NOTICE: Do not use high-pressure**

**water when rinsing the engine or engine compartment as severe engine damage could result.** [ECJ00572]

- (3) Wipe the engine and engine compartment with a dry cloth.
- (4) Wash down the hull, deck, and jet pump with fresh water.
- (5) Wipe the hull, deck, and jet pump with a dry cloth.
- (6) Wipe all vinyl and rubber components, such as the engine compartment seals, with a vinyl protectant.
- (7) To minimize corrosion, spray metallic parts of the hull, deck, and engine with a rust inhibitor.
- (8) Allow the engine compartment to air dry completely before installing the hood.
- (9) Securely install the hood in its original position.

EJU33688

## Battery care

If the watercraft will not be used for more than a month, remove the battery from the watercraft, check it, and then store it in a cool, dry place.

EWJ00792

## WARNING

**Battery electrolyte is poisonous and dangerous, causing severe burns, etc. Electrolyte contains sulfuric acid. Avoid contact with skin, eyes, or clothing.**

## Antidotes

**External: Flush with water.**

**Internal: Drink large quantities of water or milk. Follow with milk of magnesia, beaten egg, or vegetable oil. Call a physician immediately.**

**Eyes: Flush with water for 15 minutes and get prompt medical attention.**

**Batteries produce explosive gases. Keep sparks, flames, cigarettes, etc., well away. If using or charging the battery in an en-**

# Care and storage

closed space, make sure that it is well ventilated. Always shield your eyes when working near batteries.

**Keep out of the reach of children.**

To remove the battery:

- (1) Disconnect the negative (-) battery lead.
- (2) Disconnect the positive (+) battery lead.
- (3) Disconnect the breather hose.
- (4) Unhook the battery bands, and then remove the battery from the watercraft.

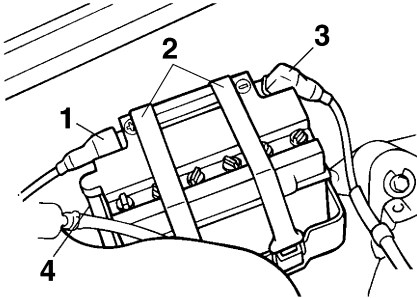

- 1 Positive (+) battery terminal: Red lead
- 2 Battery band
- 3 Negative (-) battery terminal: Black lead
- 4 Breather hose

## Checking the battery

- Make sure that the battery case is not damaged.
- Make sure that the battery terminals are not corroded or damaged.
- Make sure that the breather hose is not clogged or damaged.

## Checking the electrolyte level

Make sure that the electrolyte level is between the maximum and minimum level marks.

If the electrolyte level is low, add distilled water to raise it to the specified level. **NOTICE:** Use only distilled water for replenishing

the battery, otherwise battery life could be shortened. [ECJ00242]

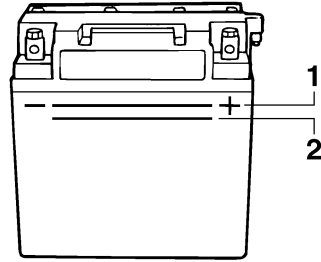

- 1 Maximum level mark
- 2 Minimum level mark

If distilled water was added, check the battery voltage.

It is recommended to have a Yamaha dealer check the battery voltage and charge the battery. If you charge the battery yourself, be sure to read and follow the instructions provided with the battery tester and charger you use. **NOTICE: Do not attempt to charge a battery hastily. Battery life could be shortened.** [ECJ00252]

## Checking the battery bands

Make sure that the battery bands are not damaged.

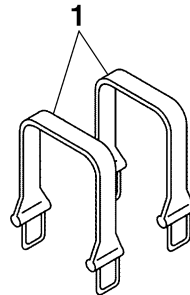

- 1 Battery band

To store the battery:

- (1) Clean the battery case using fresh water.

# Care and storage

- (2) If the battery terminals are dirty or corroded, clean them using a wire brush.
- (5) Make sure that the battery is securely held in place.

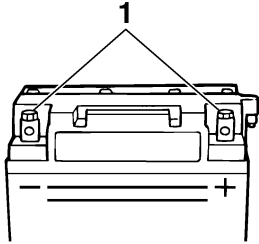

1 Battery terminal

- (3) Apply water-resistant grease to the battery terminals.

Recommended water-resistant grease:  
YAMALUBE MARINE  
GREASE/Yamaha Grease A

- (4) Store the battery in a cool, dry place.  
**NOTICE: Storing the battery in an uncharged condition can cause permanent battery damage. Check the battery periodically.** [ECJ00103]

## To install the battery:

- (1) Place the battery in the battery compartment and hook the battery bands onto the holders.
- (2) Connect the positive (+) battery lead (red) to the positive (+) battery terminal.  
**NOTICE: Reversal of the battery leads will damage the electrical parts.** [ECJ00262]
- (3) Connect the negative (-) battery lead (black) to the negative (-) battery terminal.
- (4) Connect the breather hose to the battery. **WARNING! Fire or explosion could result if the breather hose is damaged, obstructed, or not connected properly.** [EWJ00452]

# Care and storage

EJU33484

## Long-term storage

EWJ00321

### **WARNING**

**Always turn the fuel cock knob to "OFF" when storing the watercraft, otherwise fuel could leak out into the engine or engine compartment, which would create a fire hazard.**

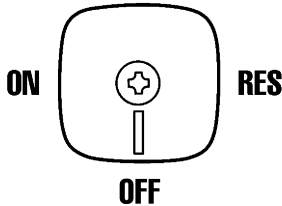

Storage for long periods of time, such as winter storage, requires preventive maintenance to ensure against deterioration. It is advisable to have the watercraft serviced by a Yamaha dealer prior to storage.

However, the following procedures can be performed easily by the owner.

EJU40763

## Cleaning

- (1) Flush the cooling water passages. (See page 50 for information on flushing the cooling water passages.)

### TIP:

If you will be storing the watercraft for a prolonged period, such as winter storage, top off the fuel tank with fresh gasoline and add fuel stabilizer and conditioner to the fuel tank according to the manufacturer's instruction before starting the engine.

- (2) Clean the watercraft. (See page 51 for information on cleaning the watercraft.)  
Wax the hull with a non-abrasive wax.

EJU40795

## Lubrication

Use a suitable marine grease applicator and spray a rust inhibitor between the inner and outer cables to lubricate the cables and purge out any dirt and moisture.

To keep moving parts sliding or rotating smoothly, lubricate them with water-resistant grease.

Recommended water-resistant grease:  
YAMALUBE MARINE  
GREASE/Yamaha Grease A

- Throttle cable (carburetor end) and choke cable (carburetor end)

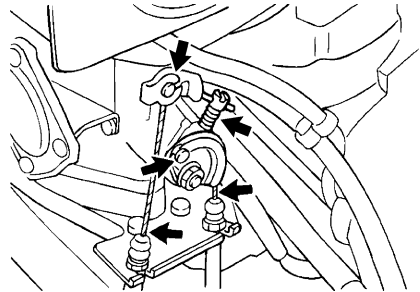

- Throttle cable (throttle lever end)  
Squeeze the throttle lever and remove the seal. Spray a rust inhibitor into the outer cable. Refit the seal securely.

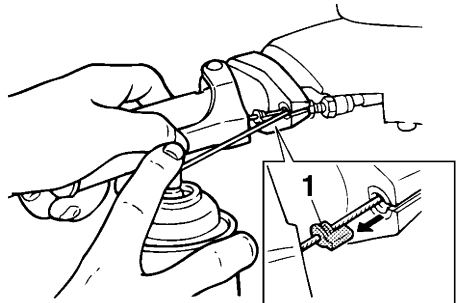

1 Seal

# Care and storage

- Steering cable ball joint (handlebar end) and steering cable inner wire (handlebar end)

To access the steering cable ball joint (handlebar end) and steering cable inner wire (handlebar end), remove the steering pole cover. (See step 1 in “Adjusting the jet thrust nozzle angle” on page 57 for information on removing the steering pole cover.)

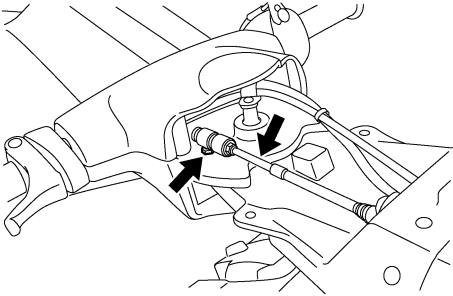

- Steering cable ball joint (jet thrust nozzle end) and steering cable inner wire (jet thrust nozzle end)

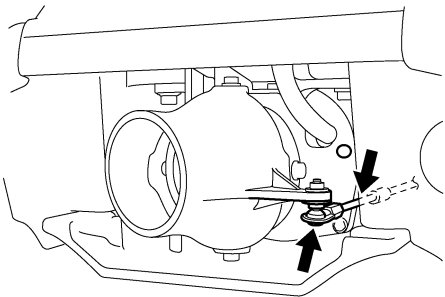

EJU40944

## Rustproofing

ECJ01361

### **NOTICE**

**Do not run the engine for more than 15 seconds on land without supplying water, otherwise the engine could overheat.**

Spray metallic parts of the hull and engine with a rust inhibitor.

To rustproof the internal engine components:

- (1) Remove the hood. (See page 23 for hood removal and installation procedures.)
- (2) Loosen the silencer cap and remove it.

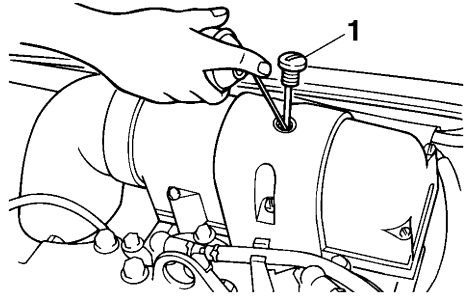

1 Silencer cap

- (3) Make sure that the area around the watercraft is clear, and then start the engine in a well-ventilated area.
- (4) Run the engine at a fast idle.
- (5) Quickly spray as much rust inhibitor as possible through the hole in the silencer cover. Keep spraying until the engine stalls (or a maximum of 15 seconds).  
**WARNING! Do not pour or spray gasoline, or any substance other than a rust inhibitor through the hole in the silencer cover. Do not spray flammable rust inhibitor products on engine surfaces while the engine is hot. Otherwise, a fire or explosion could occur.** [EWJ00302]
- (6) Securely install the silencer cap by tightening it until it stops. **NOTICE: Be sure to install the silencer cap securely after fogging the engine, otherwise water could enter the engine and cause damage.** [ECJ00153]
- (7) Securely install the hood in its original position.

# Maintenance

EJU33769

## Maintenance

Periodic checks and lubrication will keep your watercraft in the safest and most efficient condition possible. Therefore, make sure to carry out the periodic maintenance. Safety is an obligation of the watercraft owner. Proper maintenance must be carried out to keep the exhaust emission and sound levels within the regulated limits. The most important points of watercraft inspection and lubrication are explained on the following pages.

See a Yamaha dealer for genuine Yamaha replacement parts and optional accessories designed for your watercraft.

Remember, failures that are the result of the installation of parts or accessories which are not qualitatively equivalent to genuine Yamaha parts are not covered by the limited warranty.

**Maintenance, replacement, or repair of the emission control devices and system may be performed by any marine SI engine repair establishment or individual. Warranty repair, however, must be performed at an authorized Yamaha marine dealership.**

EWJ00312

### **WARNING**

Be sure to turn off the engine when you perform maintenance unless otherwise specified. If you are not familiar with machine servicing, this work should be done by a Yamaha dealer or other qualified mechanic.

EJU33803

## Tool kit

A tool kit is included with this watercraft. Place the tool kit in a waterproof bag and always

carry it with you whenever you use the watercraft.

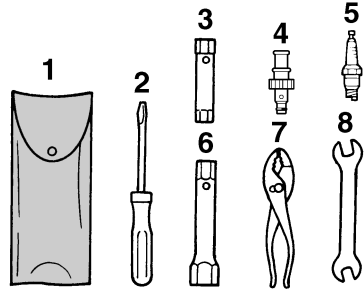

- 1 Tool bag
- 2 Screwdriver
- 3 10/12 mm box wrench
- 4 Garden hose adapter
- 5 Spark plug (one included for each cylinder)
- 6 14/21 mm box wrench
- 7 Pliers
- 8 10/12 mm open-end wrench

EJU34338

## Adjusting the steering friction

The amount of friction in the steering can be adjusted to suit operator preference.

To adjust the steering friction:

- (1) Lift the steering pole and support it with the lock pin.

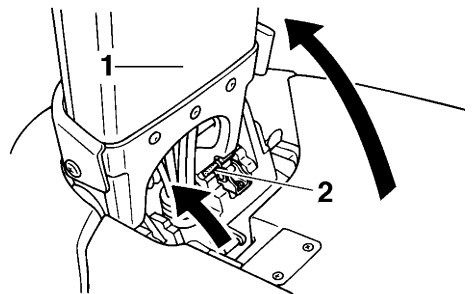

- 1 Steering pole
- 2 Lock pin

- (2) Remove the four screws, and then remove the handlebar cover.

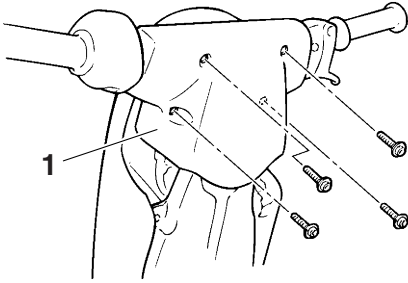

1 Handlebar cover

- (3) Turn the handlebars so that the left handlebar grip is facing down.
- (4) Loosen the locknut.
- (5) Tighten or loosen the adjusting nut until the desired amount of friction is obtained.

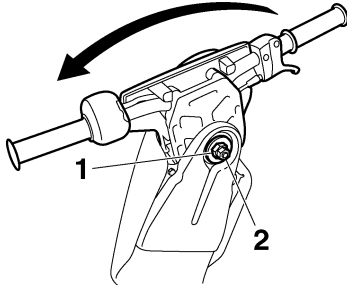

1 Adjusting nut  
2 Locknut

- (6) While holding the adjusting nut with a wrench, tighten the locknut to the specified torque.

Tightening torque:  
Locknut:  
28 N·m (2.8 kgf·m, 21 lb·ft)

- (7) Securely install the handlebar cover and four screws in their original positions.

- (8) While holding the steering pole, move the lock pin to the stowed position, and then lower the steering pole.

EJU3128A

## Adjusting the jet thrust nozzle angle

The angle of the jet thrust nozzle can be adjusted to two settings to suit operator preference.

To adjust the jet thrust nozzle angle:

- (1) Remove the two bolts, and then remove the steering pole cover.

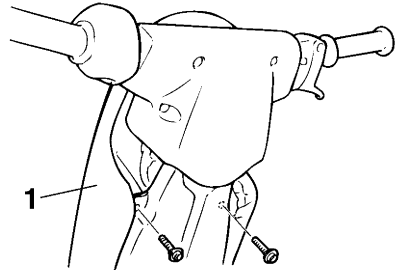

1 Steering pole cover

- (2) Pull back the outer sleeve of the steering cable joint, and then disconnect the joint from the steering cable pivot bolt.

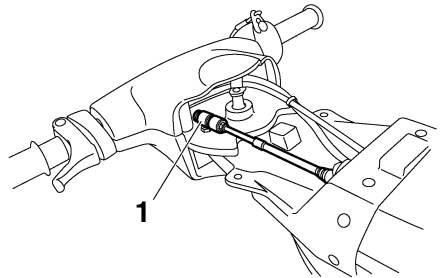

1 Steering cable joint

# Maintenance

- (3) Remove the steering cable pivot bolt.

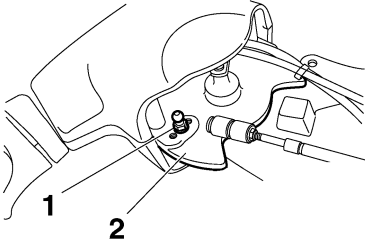

- 1 Steering cable pivot bolt  
2 Steering column

- (4) Select the nozzle angle, install the steering cable pivot bolt with the lock washer in the desired position (P1 or P2) on the steering column, and then tighten the bolt to the specified torque.

## TIP:

The outermost hole in the steering column cannot be used.

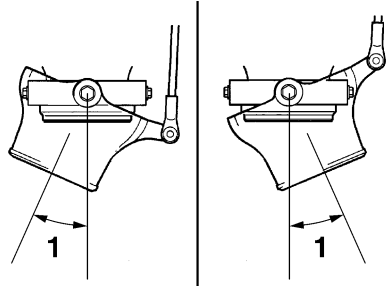

- 1 Nozzle angles

1	2
14.4°	P1
17.3°	P2

- 1 Nozzle angles

- 2 Steering cable pivot bolt positions

Standard steering cable pivot bolt position:

P2

Tightening torque:

Steering cable pivot bolt:

5 N·m (0.5 kgf·m, 3.7 lb·ft)

- (5) Securely connect the steering cable joint to the steering cable pivot bolt.  
(6) Securely install the steering pole cover and two bolts in their original positions.



EJU40831

## Periodic maintenance chart

The periodic maintenance chart gives general guidelines for periodic maintenance. Have a Yamaha dealer perform the checks in the following chart. However, maintenance may need to be performed more frequently depending on your operating conditions. If you have any questions, consult a Yamaha dealer.

This “●” mark indicates maintenance that you may do yourself.

This “○” mark indicates items to be checked and serviced by a Yamaha dealer.

Item	Operation	Initial	Thereafter every				Page
		10 hours	50 hours		100 hours	200 hours	
			6 months	12 months	12 months	24 months	
<b>Spark plugs</b>	Check, clean, replace	●/○	●/○		●/○		60
<b>Lubrication points</b>	Lubricate				●/○		54
<b>Intermediate housing</b>	Lubricate	○			●/○		61
<b>Fuel system</b>	Check				○		—
<b>Fuel filter</b>	Check	●				●	61
	Check, replace	○				○	—
<b>Fuel tank</b>	Check, clean					○	—
<b>Carburetor</b>	Check, adjust	○			○		—
<b>Engine idling speed</b>	Check, adjust				●/○		62
<b>Carburetor throttle shaft</b>	Check				○		—
<b>Bilge strainer</b>	Clean				○		—
<b>Impeller</b>	Check				○		—
<b>Jet thrust nozzle angle</b>	Check, adjust				○		—
<b>Handlebar pivot shaft</b>	Check, adjust	○			○		—
<b>Steering friction</b>	Check, adjust	○			○		—
<b>Steering master</b>	Check, adjust	○			○		—
<b>Throttle cable</b>	Check, adjust	○			○		—
<b>Choke cable</b>	Check, adjust				●/○		61
<b>Battery</b>	Check, charge				○		—
<b>Rubber coupling</b>	Check					○	—
<b>Engine mount</b>	Check					○	—
<b>Nuts and bolts</b>	Check	○			○		—

# Maintenance

EJU3437B

## Checking the spark plugs

EWJ00351



### WARNING

**Be careful not to damage the insulator when removing or installing a spark plug. A damaged insulator could allow sparks to escape, which could result in a fire or explosion.**

Remove and check the condition of the spark plugs.

The condition of a spark plug can indicate something about the condition of the engine. For example, if the center electrode portion is very white, this could indicate an intake air leak or carburetion problem in that cylinder. Do not attempt to diagnose any problems yourself. Have a Yamaha dealer service the watercraft.

### To remove a spark plug:

- (1) Remove the hood. (See page 23 for hood removal and installation procedures.)
- (2) Remove the spark plug cap.
- (3) Remove the spark plug, and then check the condition of the spark plug and the spark plug gap. If the electrode portion is significantly discolored, if electrode erosion becomes excessive, if carbon and other deposits are excessive, or if the spark plug gap is not within the specified range, replace the spark plug.

### TIP:

When the engine is operating normally, the color of the spark plug electrode portion will be a medium-to-light tan.

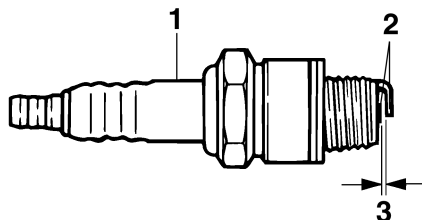

- 1 Insulator
- 2 Electrode
- 3 Spark plug gap

Specified spark plug:  
BR7HS  
Spark plug gap:  
0.6–0.7 mm (0.024–0.028 in)

### To install a spark plug:

- (1) Wipe off any dirt from the threads, insulator, and gasket surface of the spark plug.
- (2) Install the spark plug, and then tighten it to the specified torque.

Tightening torque:  
Spark plug:  
25 N·m (2.5 kgf·m, 18 lb·ft)

### TIP:

If a torque-wrench is not available when you are reinstalling a spark plug, a good estimate of the correct torque is 1/12 turn past finger-tight. When you are installing a new spark plug, a good estimate of the correct torque is 1/2 to 2/3 turn past finger-tight.

- (3) Wipe off any water or dirt inside the spark plug cap.

- (4) Install the spark plug cap by pushing it down until it is securely installed in its original position.
- (5) Securely install the hood in its original position.

EJU41182

## Lubrication points

Lubricate moving parts with water-resistant grease. (See page 54 for information on the main lubrication points.)

Recommended water-resistant grease:  
YAMALUBE MARINE  
GREASE/Yamaha Grease A

## Intermediate housing

Fill the intermediate housing with water-resistant grease through the grease nipple using a grease gun.

Grease quantity:  
Initial 10 hours or 1 month:  
20.0–22.0 cm<sup>3</sup> (0.68–0.74 US oz,  
0.71–0.78 Imp.oz)  
Every 100 hours or 12 months:  
3.0–5.0 cm<sup>3</sup> (0.10–0.17 US oz,  
0.11–0.18 Imp.oz)

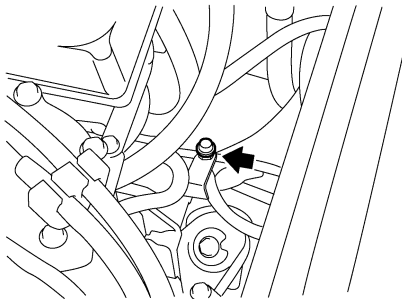

EJU34226

## Checking the fuel filter

Check the fuel filter. The fuel filter should be replaced if water or dirt is found in the filter.

Have a Yamaha dealer replace the fuel filter if necessary.

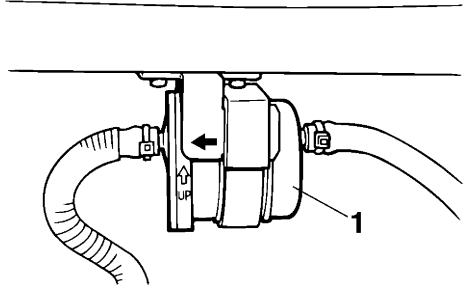

1 Fuel filter

EJU34442

## Adjusting the choke cable

Check that the choke cable is properly adjusted.

To adjust the choke cable:

- (1) Pull the choke knob out until it stops, and then release the knob. The knob should not move.
- (2) If the choke knob moves back on its own, tighten the choke knob adjusting nut slightly. If the knob is difficult to move, loosen the adjusting nut slightly.

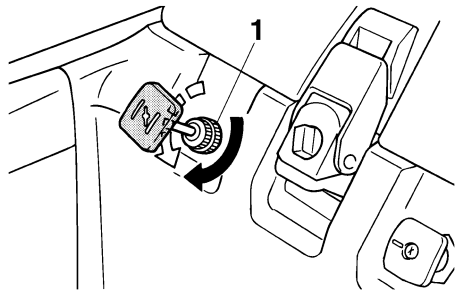

1 Choke knob adjusting nut

EJU34464

## Adjusting the carburetor

ECJ00173

### NOTICE

If the carburetor settings are disturbed by someone who does not have the neces-

# Maintenance

---

**sary technical knowledge, poor engine performance and damage may result.**

The carburetor is a vital part of the engine and requires very sophisticated adjustments. Most adjustments should be left to a Yamaha dealer who has the professional knowledge and experience to make them.

However, the operator may adjust the engine idling speed as part of the usual maintenance routine.

EJU34472

## **Adjusting the engine idling speed**

- (1) Place the watercraft in the water.
- (2) Start the engine and warm it up for 1 to 2 minutes.
- (3) While using a diagnostic tachometer, turn the throttle stop screw to adjust the engine idling speed to specification. Turn the throttle stop screw clockwise to increase the engine idling speed or counterclockwise to decrease the engine idling speed.

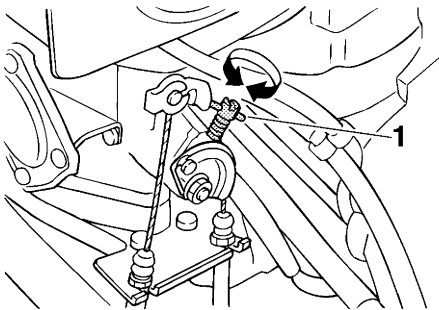

1 Throttle stop screw

Engine idling speed: 1300 $\pm$ 50 r/min
---

EJU34543

## Specifications

### Watercraft capacity:

Maximum people on board:  
1 person

### Dimensions and weight:

Length:  
2240 mm (88.2 in)  
Width:  
680 mm (26.8 in)  
Height:  
660 mm (26.0 in)  
Dry weight:  
139 kg (306 lb)

### Performance:

Maximum output (according to ISO 8665/SAE J1228):  
48.5 kW at 6250 r/min  
Maximum fuel consumption:  
29.0 L/h (7.7 US gal/h, 6.4 Imp.gal/h)  
Cruising range at full throttle:  
0.62 hour  
Trolling speed:  
1300 ±50 r/min

### Engine:

Engine type:  
2-stroke  
Number of cylinders:  
2  
Engine displacement:  
701 cm<sup>3</sup>  
Bore × stroke:  
81.0 × 68.0 mm (3.19 × 2.68 in)  
Compression ratio:  
7.2 : 1  
Lubrication system:  
Pre-mixed fuel and oil  
Cooling system:  
Water  
Starting system:  
Electric  
Ignition system:  
C.D.I.  
Spark plug (NGK):  
BR7HS  
Spark plug gap:  
0.6–0.7 mm (0.024–0.028 in)  
Battery capacity:  
12 V, 19 Ah

Charging system:  
Flywheel magneto

### Drive unit:

Propulsion system:  
Jet pump  
Jet pump type:  
Axial flow, single stage  
Impeller rotation:  
Counterclockwise  
Jet thrust nozzle angle:  
P1: 14.4+14.4°  
P2: 17.3+17.3°

### Fuel and oil:

Recommended fuel:  
Regular unleaded gasoline  
Minimum octane rating (PON):  
86  
Minimum octane rating (RON):  
90  
Recommended engine oil:  
YAMALUBE 2-W or TC-W3 outboard motor oil or equivalent  
Fuel mixing ratio (fuel to oil):  
50 : 1  
Fuel tank total capacity:  
18 L (4.8 US gal, 4.0 Imp.gal)  
Fuel tank reserve capacity:  
5.5 L (1.5 US gal, 1.2 Imp.gal)

# Trouble recovery

EJU34562

## Troubleshooting

If you have any trouble with your watercraft, use the troubleshooting chart to check for the possible cause.

If you cannot find the cause, consult a Yamaha dealer.

EJU34576

### Troubleshooting chart

TROUBLE	POSSIBLE CAUSE		REMEDY	PAGE
<b>Engine does not start (Starter motor does not turn over)</b>	Engine shut-off switch	Clip not in place	Install clip	19
	Fuse	Burned out	Replace fuse and check wiring	67
	Battery	Run down	Recharge	51
		Poor terminal connections	Tighten as required	51
		Terminal corroded	Clean or replace	51
	Starter motor	Faulty	Have serviced by Yamaha dealer	—
<b>Engine does not start (Starter motor turns over)</b>	Fuel cock	Turned to "OFF"	Turn fuel cock knob to "ON"	21
	Fuel	Empty	Refill as soon as possible	28
		Stale or contaminated	Have serviced by Yamaha dealer	—
	Fuel tank	Water or dirt present	Have serviced by Yamaha dealer	—
	Spark plug	Fouled or defective	Replace	60
	Spark plug cap	Not connected or loose	Connect properly	60
	Crankcase	Filled with water	Have serviced by Yamaha dealer	69
	Fuel filter	Clogged or water pooled	Have serviced by Yamaha dealer	61
	Choke	Knob moves back on its own	Tighten choke knob adjusting nut	61

# Trouble recovery

TROUBLE	POSSIBLE CAUSE		REMEDY	PAGE
<b>Engine runs irregularly or stalls</b>	Fuel	Empty	Refill as soon as possible	28
		Stale or contaminated	Have serviced by Yamaha dealer	—
		Too much oil in fuel mixing ratio	Correct fuel-to-oil ratio to 50:1	28
	Choke	Knob is left pulled	Push fully in	21
	Fuel filter	Clogged or water pooled	Have serviced by Yamaha dealer	61
	Fuel tank	Water or dirt present	Have serviced by Yamaha dealer	—
	Spark plug	Fouled or defective	Replace	60
		Incorrect heat range	Replace	60
		Gap incorrect	Replace	60
	Spark plug cap	Not connected or loose	Connect properly	60
		Cracked, torn or damaged	Have serviced by Yamaha dealer	—
	Electrical wiring	Loose electrical connections	Have serviced by Yamaha dealer	—
	Carburetor	Incorrect idle adjustment	Have serviced by Yamaha dealer	—
		Clogged	Have serviced by Yamaha dealer	61
<b>Watercraft slow or loses power</b>	Cavitation	Jet intake clogged	Clean	66
		Impeller damaged or worn	Have serviced by Yamaha dealer	66
	Engine overheated	Jet intake clogged	Clean	66
	Fuel filter	Clogged	Have serviced by Yamaha dealer	61
	Spark plug	Fouled or defective	Replace	60
		Incorrect heat range	Replace	60
		Gap incorrect	Replace	60
	Spark plug caps	Not connected or loose	Connect properly	60
	Fuel	Stale or contaminated	Have serviced by Yamaha dealer	—

# Trouble recovery

EJU34625

## Emergency procedures

EJU34635

### Cleaning the jet intake and impeller

EWJ00783

#### **WARNING**

Before attempting to remove weeds or debris from the jet intake or impeller area, shut the engine off and remove the clip from the engine shut-off switch. Severe injury or death could result from coming in contact with the rotating parts of the jet pump.

If weeds or debris gets caught in the jet intake or impeller, cavitation can occur, causing jet thrust to decrease even though engine speed rises. If this condition is allowed to continue, the engine will overheat and may seize.

**NOTICE:** If weeds or debris gets caught in the jet intake, do not operate the watercraft above trolling speed until they have been removed. [ECJ00654]

If there is any sign that the jet intake or impeller is clogged with weeds or debris, return to shore and check the intake and impeller. Al-

ways stop the engine before beaching the watercraft.

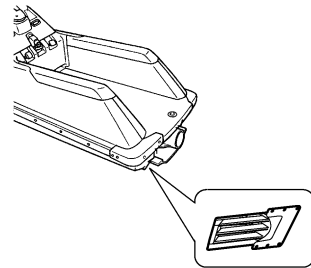
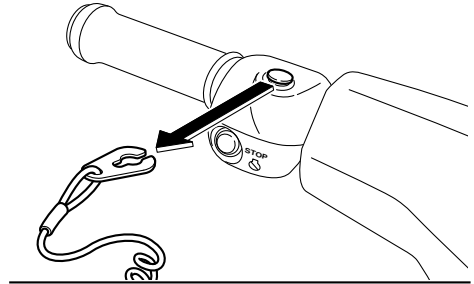

- (1) Place a suitable clean cloth or carpeting underneath the watercraft to protect it from abrasions and scratches. Turn the watercraft on its side as shown. **NOTICE:** Always turn the watercraft over onto its port (left) side. When turning the watercraft on its side, support the bow so that the handlebars are not bent or damaged. [ECJ00662]

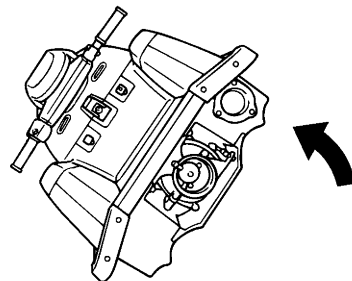



# Trouble recovery

- (2) Remove any weeds or debris from around the jet intake, drive shaft, impeller, jet pump housing, and jet thrust nozzle.

If debris is difficult to remove, consult a Yamaha dealer.

EJU34642

## Jumping the battery

If the watercraft battery has run down, the engine can be started using a 12-volt booster battery and jumper cables.

EJU34654

## Connecting the jumper cables

EWJ01251



### WARNING

To avoid battery explosion and serious damage to the electrical system:

- Do not reverse the polarity of the jumper cables when connecting to the batteries.
- Do not connect the negative (-) jumper cable to the negative (-) terminal of the watercraft battery.
- Do not touch the positive (+) jumper cable to the negative (-) jumper cable.

- (1) Connect the positive (+) jumper cable to the positive (+) battery terminals of both batteries.
- (2) Connect one end of the negative (-) jumper cable to the negative (-) battery terminal of the booster battery.

- (3) Connect the other end of the negative (-) jumper cable to an unpainted bolt on the cylinder head.

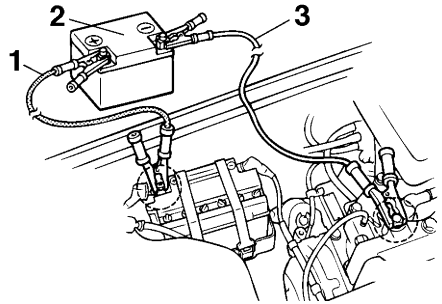

- 1 Positive (+) jumper cable
- 2 Booster battery
- 3 Negative (-) jumper cable

- (4) Start the engine, and then disconnect the jumper cables by reversing the steps above. (See page 19 for information on starting the engine.)

EJU34676

## Replacing the fuse

If the fuse is blown, replace it with the proper fuse.

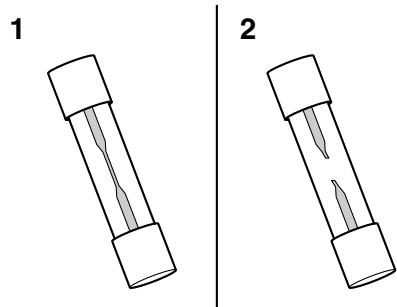

- 1 Good fuse
- 2 Blown fuse

### To replace the fuse:

- (1) Remove the hood. (See page 23 for hood removal and installation procedures.)
- (2) Loosen the cap and remove it.
- (3) Pull out the red lead to pull out the fuse holder from the electrical box.

# Trouble recovery

- (4) Open the fuse holder and replace the fuse with one of the correct amperage. **WARNING! Do not use fuses of a different amperage than recommended. Substitution with a fuse that has an improper rating can cause extensive electrical system damage and possible fire.** [EJVJ00803]

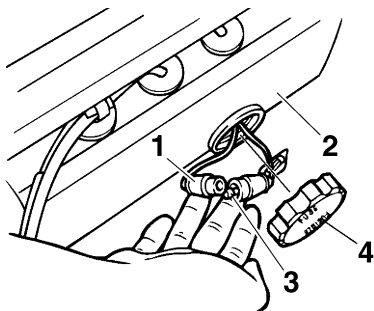

- 1 Fuse holder
- 2 Electrical box
- 3 Fuse
- 4 Cap

Fuse amperage:  
Battery fuse:  
10 A

- (5) Insert the fuse holder into the electrical box.
- (6) Securely install the cap by tightening it until it stops.
- (7) Securely install the hood in its original position.

EJUJ34705

## Towing the watercraft

EWJ00812



**WARNING**

- The operator of the towing boat must keep speed to a minimum and avoid traffic or obstacles which could be a hazard to the operator on the watercraft.

- The towline should be long enough so that the watercraft will not collide with the towing boat when slowing down.

If the watercraft becomes inoperative in the water, it can be towed to shore.

### To tow the watercraft:

Use a towline that is three times the combined length of the towing boat and the watercraft.

- (1) Securely attach the towline to the bow rope hole of the watercraft being towed.

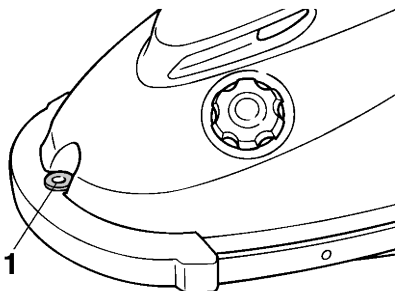

- 1 Bow rope hole

- (2) Ride the watercraft with your body weight supported on the riding tray. Hold on to the handlebars in order to balance the watercraft and keep the bow up out of the water. **NOTICE: The bow must be kept up out of the water during towing, otherwise water could flood the engine compartment or water could flow back into the engine, causing severe engine damage.** [ECJ01331]

Tow the watercraft at 8 km/h (5 mph) or less. **NOTICE: Tow the watercraft at 8 km/h (5 mph) or less, otherwise water could flood the engine compartment or water could flow back into the engine, causing severe engine damage.** [ECJ01322]

EJU34735

## Submerged watercraft

If the watercraft is submerged or flooded with water, drain the bilge water from the engine compartment. Then, have a Yamaha dealer service the watercraft as soon as possible.

- (1) Remove the watercraft from the water, and then remove the hood.
- (2) Turn the fuel cock knob to “OFF”.
- (3) Turn the watercraft over far enough to drain the bilge water from the engine compartment. **NOTICE: Turning the watercraft on its side with the hood removed could cause damage to the steering pole. Use two people to provide enough support to make sure that the steering pole is not damaged.**

[ECJ00702]

- (4) Turn the watercraft upright again.
- (5) Have the watercraft serviced by a Yamaha dealer as soon as possible. **NOTICE: Be sure to have a Yamaha dealer inspect the watercraft. Otherwise, serious engine damage could result.** [ECJ00792]

# Index

---

2-stroke engine oil .....	28	Fuel and engine oil requirements .....	27
<b>A</b>		Fuel cock knob.....	21
After removing the watercraft from the water .....	49	Fuel filter, checking .....	61
<b>B</b>		Fuel level check.....	35
Battery care.....	51	Fuel system checks .....	35
Battery checks .....	36	Fuel tank, filling .....	28
Battery, jumping.....	67	Fuse, replacing.....	67
Beaching the watercraft.....	49	<b>G</b>	
Bilge water check.....	36	Getting to know your watercraft .....	40
Bilge water, draining .....	29	Glossary, watercraft .....	16
Bilge water, draining on water .....	29	<b>H</b>	
Boarding and starting in deep water.....	47	Hazard information.....	13
Boarding and starting in shallow water....	46	Hood .....	23
Bow rope hole.....	24	Hood check.....	39
<b>C</b>		Hull and deck check .....	39
Capsized watercraft .....	48	<b>I</b>	
Carburetor, adjusting .....	61	Identification numbers .....	1
Choke cable, adjusting .....	61	<b>J</b>	
Choke knob.....	21	Jet intake and impeller, cleaning.....	66
Cleaning .....	54	Jet intake checks .....	39
Cleaning the watercraft.....	51	Jet thrust nozzle angle, adjusting .....	57
Cooling water pilot outlet.....	21	Jumper cables, connecting.....	67
Cooling water pilot outlet check .....	39	<b>L</b>	
Craft Identification Number (CIN).....	1	Labels, important .....	3
Cruising limitations.....	9	Labels, other .....	7
<b>E</b>		Labels, warning .....	4
Emergency procedures.....	66	Launching the watercraft .....	41
Engine break-in .....	32	Learning to operate your watercraft.....	40
Engine compartment check .....	35	Leaving the watercraft.....	43
Engine idling speed, adjusting .....	62	Limitations on who may operate the watercraft.....	8
Engine overheat warning system.....	22	Long-term storage .....	54
Engine serial number .....	1	Lubrication .....	54
Engine shut-off cord (lanyard) check .....	38	Lubrication points .....	61
Engine shut-off switch .....	19	<b>M</b>	
Engine stop switch.....	19	Main components, location of .....	17
Engine unit check.....	36	Maintenance.....	56
Enjoy your watercraft responsibly.....	15	Manufactured date label .....	2
Equipment.....	23	Mixing fuel and oil .....	28
<b>F</b>		<b>O</b>	
Fire extinguisher check .....	39	Operating in weeded areas .....	49
Fire extinguisher container.....	25	Operating positions.....	40
Fire extinguisher container checks .....	39	Operating the watercraft .....	43
Flushing the cooling water passages.....	50	Operating your watercraft .....	40
Fuel .....	27	Operation requirements .....	10

## **P**

Periodic maintenance chart .....	59
Post-launch checks .....	39
Post-operation care .....	50
Pre-launch checks .....	35
Pre-operation check points .....	35
Pre-operation checklist.....	33
Primary Identification (PRI-ID) number .....	1

## **R**

Recommended equipment .....	12
Rustproofing .....	55

## **S**

Safe boating rules .....	14
Safety equipment check .....	39
Spark plugs, checking .....	60
Start switch .....	19
Starting off .....	45
Starting the engine on water.....	41
Steering friction, adjusting .....	56
Steering pole.....	20
Steering pole check .....	37
Steering system .....	20
Steering system checks.....	36
Stern rope hole .....	24
Stopping the engine.....	43
Stopping the watercraft .....	45
Storage pouch .....	24
Storage pouch checks.....	38
Submerged watercraft .....	69
Switch checks.....	38

## **T**

Throttle lever .....	20
Throttle lever checks.....	37
Tool kit .....	56
Towing the watercraft .....	68
Transporting .....	30
Troubleshooting .....	64
Troubleshooting chart.....	64
Turning the watercraft.....	43

## **W**

Water separator .....	22
Water separator check.....	36
Watercraft characteristics.....	13
Watercraft control functions .....	19



Printed in Japan  
April 2018-0.1 × 1 CR

Printed on recycled paper